

PS16c

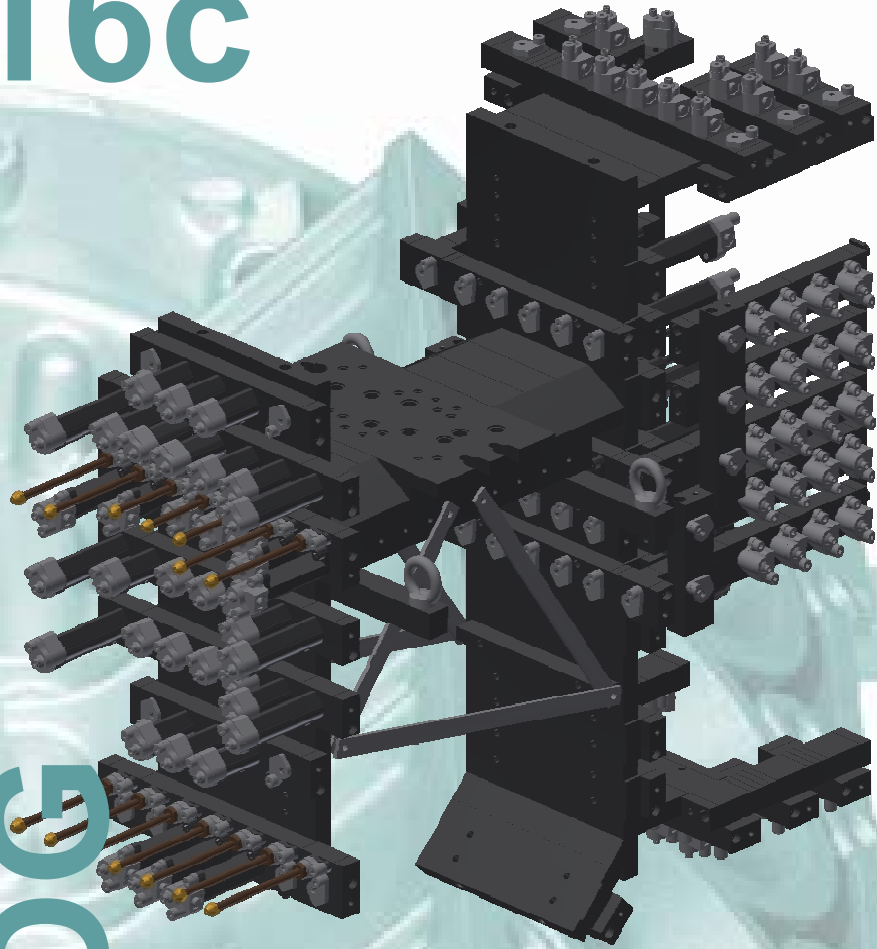

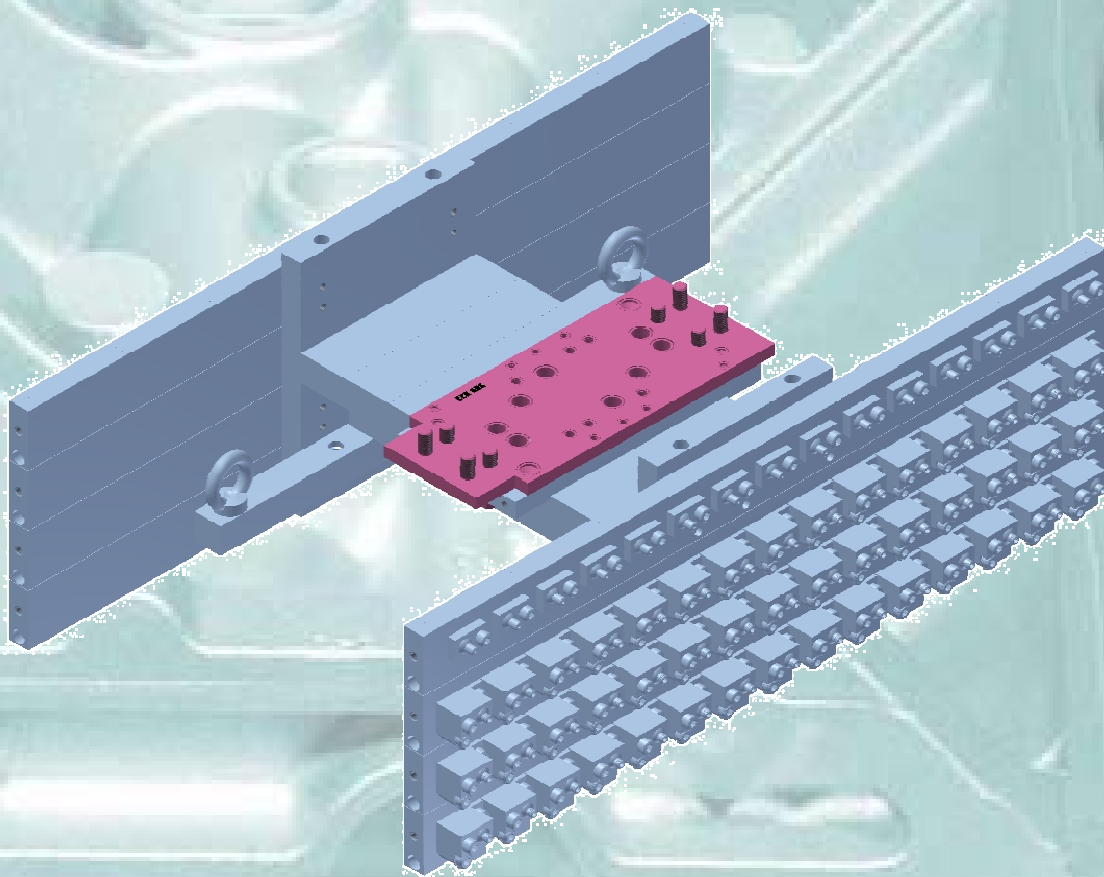









KATALOG CATALOG







Artikelgruppe 0 Zubehör prod.group 0 addons



Artikelgruppe 0 Zubehör
 prod.group 0 addons

000.1 Artikelnr./ partno.303969		
Zwischenadapter PS16-6 an PSM2, komplett intermediate adapter PS16-6 on PSM2		
000.2 Artikelnr./ partno.303983		
Zwischenadapter PS16-4/PSM2 VL2004/PSM2, komplett intermediate adapter PS16-4/PSM2 VL2004/PSM2, complete		
000.3 Artikelnr./ partno.306974		
Spezialverteilerplatte VL2004 (4-Kr.) an PSM3, komplett Special-distributor plate PSM3 to PS16-4 / VL2004		
000.4 Artikelnr./ partno.307111		
Zwischenadapter PS16/PSM224 an PSM2 komplett Intermediate adaptor PS16/PSM224 to PSM2		
000.5 Artikelnr./ partno.307242		
Zwischenadapter PS16-4 an PSM336/PSM3, komplett intermediate adapter PS16/PSM2		







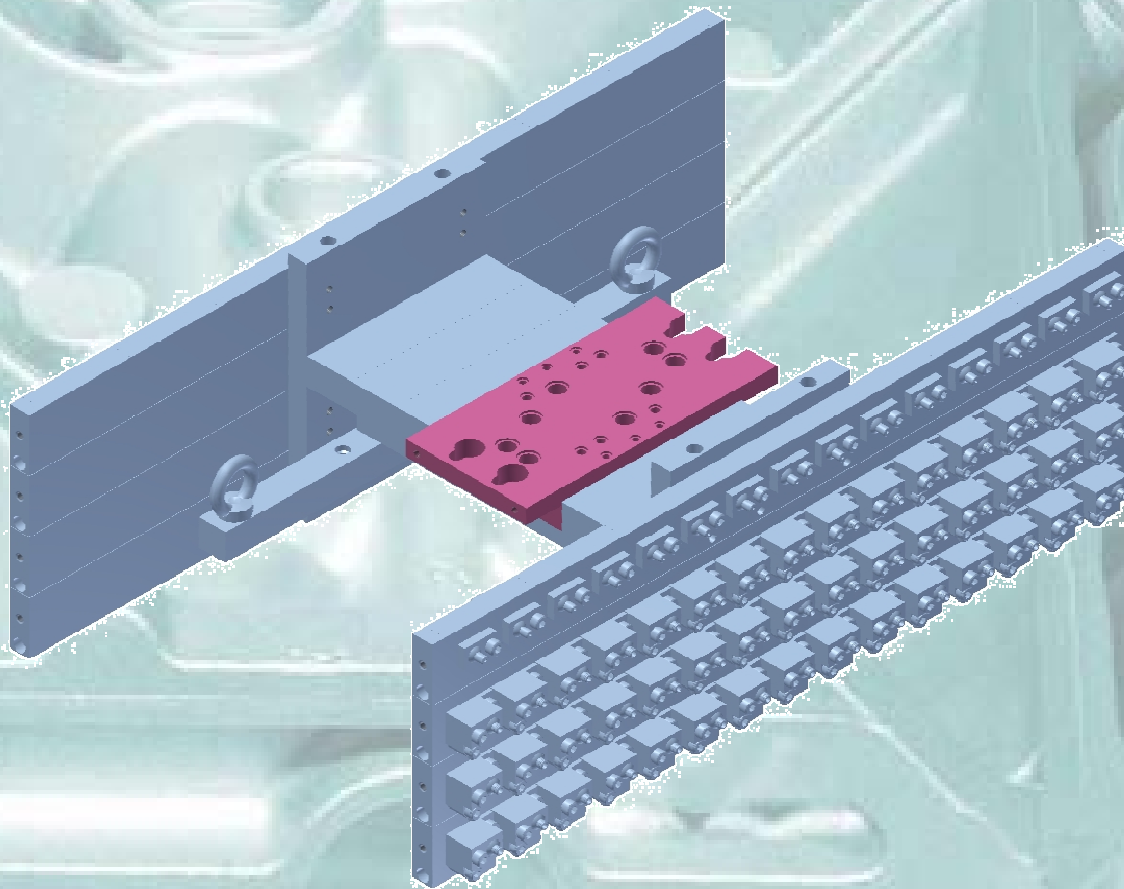



Artikelgruppe 0 Zubehör
 prod.group 0 addons

<p>000.6 Artikelnr./ partno.309822</p>		
<p>Zwischenplatte 8 zu 6Kreis für PSM4 mit 6-Kreis -SPW Intermediateplate 8 to 6 for PSM4 with 6-circuit tool</p>		
<p>000.7 Artikelnr./ partno.319894</p>		
<p>Spezialverteilerplatte VL2004 (4-Kr.) an PSM3+1, komplett Special-distributor plate PSM3+1 to PS16-4 / VL2004</p>		
<p>000.8 Artikelnr./ partno.325679</p>		
<p>Zwischenadapter Wollin an IDRA PS16-6 (6-Kr.) an LS45 (6-Kr.), komplett Intermediate adapter PS16-PSM3 to IDRA LS45 6-circuit, compl.</p>		



Artikelgruppe 10 Zubehör prod.group 10 addons







Artikelgruppe 10 Zubehör
 prod.group 10 addons

010.1 Artikelnr./ partno.140921		
Adapter PS16-6/SM-4Kreis/PSM-4Kreis komplett Adaptor PS16 - SM 4 circuit		
010.2 Artikelnr./ partno.143511		
Adapter PS16-6/PSM324/PSM336/PSM436 komplett Adaptor PS16-6/PSM324/PSM336/PSM436 complete		
010.3 Artikelnr./ partno.153320		
Adapter PS16/SM-2Kreis komplett Adaptor PS16/SM2 circuit complete		
010.4 Artikelnr./ partno.207696		
Adapter PS16-8/PSM448 komplett Adaptor PS16-8/PSM448		
010.5 Artikelnr./ partno.215947		
Adapter PS16-6/PSM224 komplett Adaptor PS16-6/PSM224		

Artikelgruppe 10 Zubehör
 prod.group 10 addons

<p>010.6 Artikelnr./ partno.300248</p> <p>Adapter PS16-8/PSM448 bewegliche Seite 8 Kreise</p> <p>Adaptor PS16-8/PSM448 moveable side - 8 circuits</p>		
<p>010.7 Artikelnr./ partno.303011</p> <p>Adapter PS16-6/PSM324-6/PSM336/PSM436/PSM3,6 komplett</p> <p>Adaptor, narrow PS16-6, complete</p>		
<p>010.8 Artikelnr./ partno.303862</p> <p>Adapter PS16/PSM2 komplett</p> <p>Adaptor PS16/PSM2 complete</p>		
<p>010.9 Artikelnr./ partno.304071</p> <p>Adapter B3/F2 PS16/PSM2 bew. 3 Kreise / fest 2 Kreise</p> <p>Adaptor B3/F2 PS16/PSM2</p>		
<p>010.10 Artikelnr./ partno.305147</p> <p>Adapter PS16/PSM1 komplett</p> <p>Adaptor PS16-6/PSM1 complete</p>		







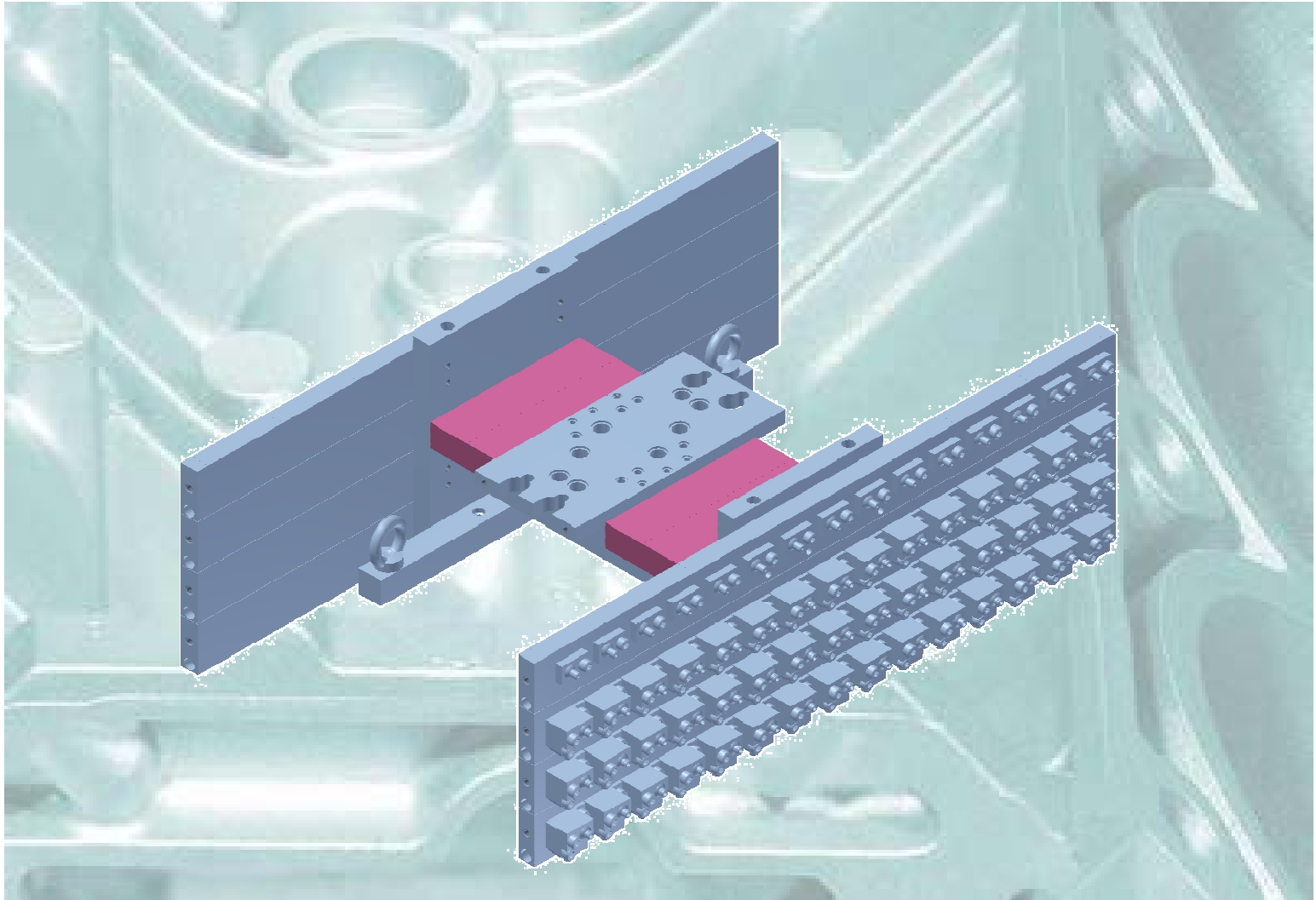



Artikelgruppe 10 Zubehör
prod.group 10 addons

010.11 Artikelnr./ partno.307006		
Adapter PS16/PSM2, schmal komplett Adaptor PS16/PSM2, narrow complete		
010.12 Artikelnr./ partno.801611		
Adapter PS16/PSM2 für 6-Kreise, K1-K5 und K2-K6 verbunden, komplett Adaptor PS16/PSM2 complete		









Artikelgruppe 11 Zubehör prod.group 11 addons

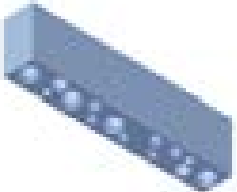



Artikelgruppe 11 Zubehör
 prod.group 11 addons

<p>011.1 Artikelnr./ partno.143529</p> <p>Adaptermodul 50mm PS16/PS16C-6, komplett</p> <p>Adaptor module 50mm PS16/PS16C-6, complete</p>		
<p>011.2 Artikelnr./ partno.143933</p> <p>Adaptermodul 25mm PS16/PS16C-6, komplett</p> <p>Adaptor module 25mm PS16/PS16C-6, complete</p>		
<p>011.3 Artikelnr./ partno.207712</p> <p>Adaptermodul 50mm PS16/PS16C-8, komplett</p> <p>Adaptor module 50mm PS16/PS16C-8, complete</p>		
<p>011.4 Artikelnr./ partno.207746</p> <p>Adaptermodul 25mm PS16/PS16C-8, komplett</p> <p>Adaptor module 25mm PS16/PS16C-8, complete</p>		
<p>011.5 Artikelnr./ partno.224246</p> <p>Adaptermodul 25mm, 90° gedreht PS16/PS16C-6, komplett</p> <p>Adaptor module 25mm, 90° turned PS16/PS16C-6, complete</p>		

Artikelgruppe 11 Zubehör
 prod.group 11 addons

<p>011.6 Artikelnr./ partno.300591</p> <p>Adaptermodul 50mm (>300) PS16/PS16C-6, kompl. für Adaptermodullg.>300mm</p> <p>Adaptor module 50mm (>300) PS16/PS16C-6, complete, for longer than 300mm</p>		
<p>011.7 Artikelnr./ partno.305557</p> <p>Adaptermodulabzweigung PS16/PS16C-8, komplett</p> <p>Adaptor module junction PS16/PS16C-8, complete</p>		
<p>011.8 Artikelnr./ partno.305753</p> <p>Adapterschliessleiste PS16-6, komplett</p> <p>Cover for adaptor PS16-6, complete</p>		
<p>011.9 Artikelnr./ partno.800174</p> <p>Adaptermodul 50mm, 90° gedreht PS16/PS16C-8, komplett</p> <p>Adaptor module 50mm, turned 90° PS16/PS16C-8, complete</p>		
<p>011.10 Artikelnr./ partno.801372</p> <p>Adaptermodul 50mm (>300) PS16/PS16C-8, kompl. für Adaptermodullg.>300mm</p> <p>Adaptor module 50mm (>300) PS16/PS16C-8, complete, for longer than 300mm</p>		







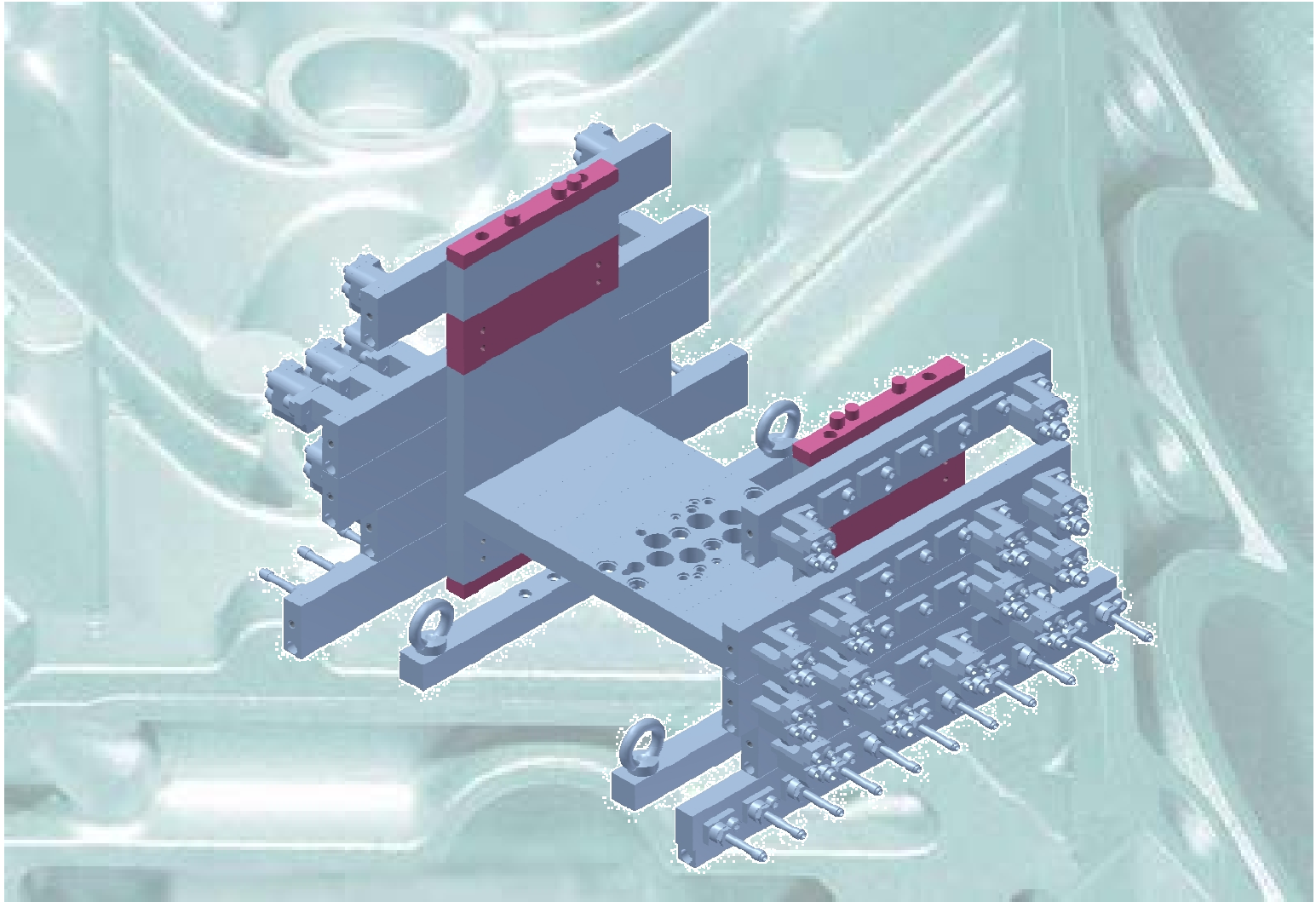



Artikelgruppe 011 Zubehör
prod.group 011 addons

011.11 Artikelnr./ partno.801442		
Adaptermodul 25mm, 90° gedreht PS16/PS16C-6, komplett Adaptor module 25mm, 90° turned PS16/PS16C-6, complete		











Artikelgruppe 20 Zubehör prod.group 20 addons













Artikelgruppe 20 Zubehör
 prod.group 20 addons

020.1 Artikelnr./ partno.147017		
Verteilerumlenkung HO PS16/PS16C-6, komplett, hinten/oben sprühend Distributor deflection HO PS16/PS16C-6, comple, spraying front/above		
020.2 Artikelnr./ partno.147025		
Verteilerumlenkung HU PS16/PS16C-6, komplett, hinten/unten sprühend Distributor deflection HU PS16/PS16C-6, comple, spraying rear/down		
020.3 Artikelnr./ partno.147827		
Verteilerdistanzmodul 60mm PS16/PS16C-6, komplett Distribution distance module 60mm PS16/PS16C-6, complete		
020.4 Artikelnr./ partno.147843		
Verteilerdistanzmodul 20mm PS16/PS16C-6, komplett Distribution distance module 20mm PS16/PS16C-6, complete		
020.5 Artikelnr./ partno.150185		
Verteilerschließplatte U PS16/PS16C-6, komplett, mit O-Ringen Distributor cover below PS16/PS16C-6, complete, with O-rings		







Artikelgruppe 20 Zubehör
 prod.group 20 addons

020.6 Artikelnr./ partno.150193		
Verteilerschließplatte O PS16/PS16C-6, komplett, ohne O-Ringe Distributor cover above PS16/PS16C-6, complete, without O-rings		
020.7 Artikelnr./ partno.207852		
Verteilerschließplatte U PS16/PS16C-8, komplett, mit O-Ringen Distributor cover below PS16/PS16C-8, complete, with O-rings		
020.8 Artikelnr./ partno.207878		
Verteilerschließplatte O PS16/PS16C-8, komplett, ohne O-Ringe Distributor cover above PS16/PS16C-8, complete, without O-rings		
020.9 Artikelnr./ partno.208009		
Verteilerdistanzmodul 60mm PS16/PS16C-8, komplett Distribution distance module 60mm PS16/PS16C-8, complete		
020.10 Artikelnr./ partno.208017		
Verteilerdistanzmodul 20mm PS16/PS16C-8, komplett Distribution distance module 20mm PS16/PS16C-8, complete		

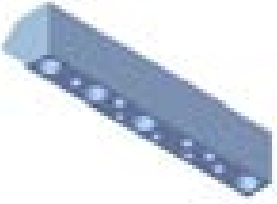
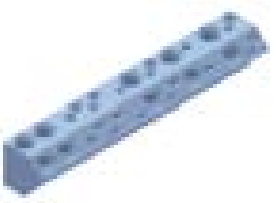
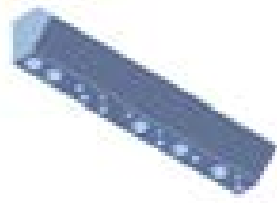
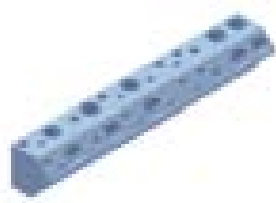









Artikelgruppe 20 Zubehör
 prod.group 20 addons

020.11 Artikelnr./ partno.208058		
Verteilerumlenkung HO PS16/PS16C-8, komplett, hinten/oben sprühend Distributor deflection HO PS16/PS16C-8, comple, spraying front/above		
020.12 Artikelnr./ partno.208066		
Verteilerumlenkung HU PS16/PS16C-8, komplett, hinten/unten sprühend Distributor deflection HU PS16/PS16C-8, comple, spraying rear/down		
020.13 Artikelnr./ partno.230813		
Verteileranschlußleiste PS16/PS16C-6, komplett Distribution connection strip PS16/PS16C-6, complete		
020.14 Artikelnr./ partno.300549		
Verteileranschlußleiste PS16/PS16C-8, komplett Distribution connection strip PS16/PS16C-8, complete		
020.15 Artikelnr./ partno.306127		
Verteilerumlenkung 45° VO PS16/PS16C-6, komplett, vorne/oben sprühend Distributor deflection 45° VO PS16/PS16C-6, complete, spraying front/above		











Artikelgruppe 20 Zubehör
 prod.group 20 addons

020.16 Artikelnr./ partno.306128		
Verteilerumlenkung 45° VU PS16/PS16C-6, komplett, vorne/unten sprühend Distributor deflection 45° VU PS16/PS16C-6, complete, spraying front/down		
020.17 Artikelnr./ partno.306129		
Verteilerumlenkung 45° VO PS16/PS16C-8, komplett, vorne/oben sprühend Distributor deflection 45° VO PS16/PS16C-8, complete, spraying front/above		
020.18 Artikelnr./ partno.306130		
Verteilerumlenkung 45° VU PS16/PS16C-8, komplett, vorne/unten sprühend Distributor deflection 45° VU PS16/PS16C-8, complete, spraying front/down		
020.19 Artikelnr./ partno.306284		
Verteilerumlenkung 45° HU PS16/PS16C-6, komplett, hinten/unten sprühend Distributor deflection 45° HU PS16/PS16C-6, complete, spraying rear/down		
020.20 Artikelnr./ partno.306285		
Verteilerumlenkung 45° HO PS16/PS16C-6, komplett, hinten/oben sprühend Distributor deflection 45° HO PS16/PS16C-6, complete, spraying rear/above		

Artikelgruppe 20 Zubehör
 prod.group 20 addons

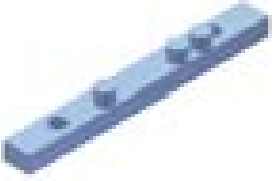
<p>020.21 Artikelnr./ partno.306295</p>		
<p>Verteilerumlenkung 45° HO PS16/PS16C-8, komplett, hinten/oben sprühend Distributor deflection 45° HO PS16/PS16C-8, complete, spraying rear/above</p>		
<p>020.22 Artikelnr./ partno.306296</p>		
<p>Verteilerumlenkung 45° HU PS16/PS16C-8, komplett, hinten/unten sprühend Distributor deflection 45° HU PS16/PS16C-8, complete, spraying rear/down</p>		
<p>020.23 Artikelnr./ partno.307736</p>		
<p>Verteilerdistanzmodul 15mm PS16/PS16C-6, komplett Distribution distance module 15mm PS16/PS16C-6, complete</p>		
<p>020.24 Artikelnr./ partno.308132</p>		
<p>Verteilerumlenkung VU mit Durchgang PS16/PS16C-6, komplett, vorne unten sprühend Distributor deflection VU with pass PS16/PS16C-6, complete (spray front-down)</p>		
<p>020.25 Artikelnr./ partno.308144</p>		
<p>Verteilerumlenkung VO mit Durchgang PS16/PS16C-6, komplett, vorne oben sprühend Distributor deflection VO with pass PS16/PS16C-6, complete (spray front-above)</p>		







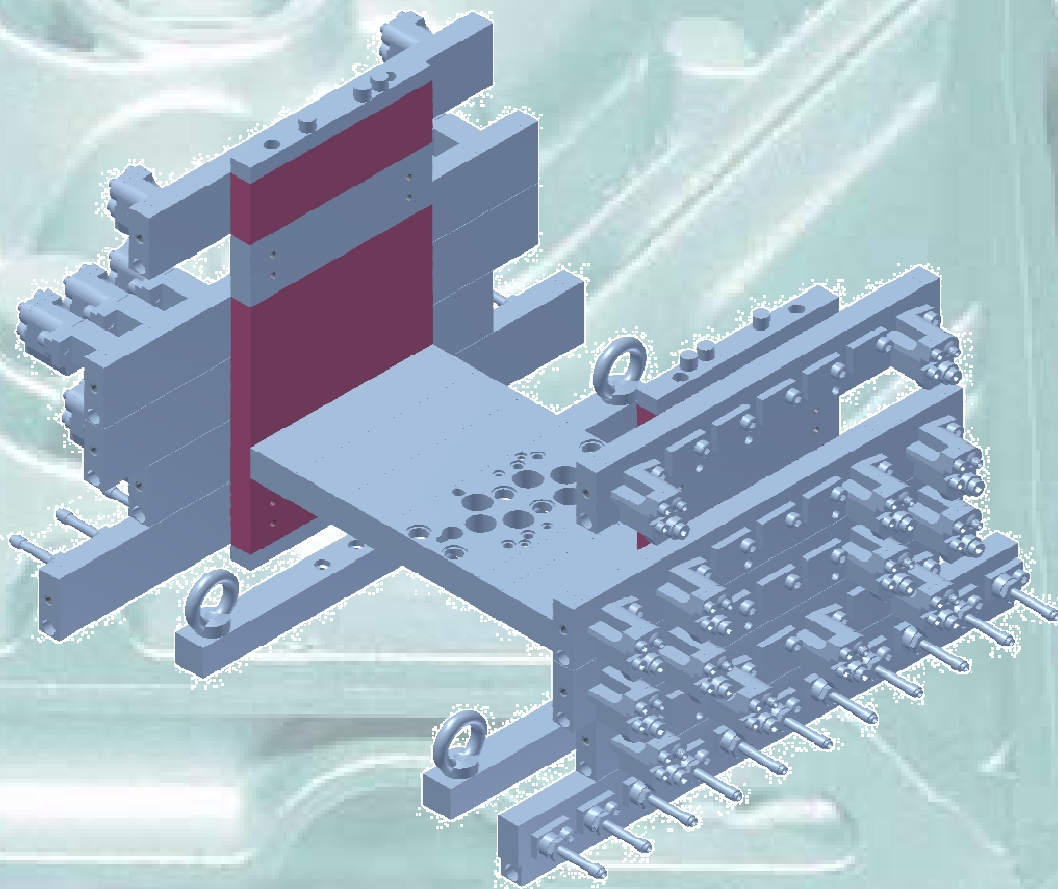

Artikelgruppe 20 Zubehör
 prod.group 20 addons

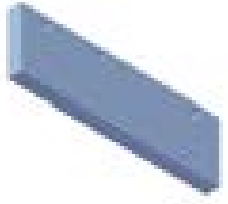
020.26 Artikelnr./ partno.800204		
Verteilerumlenkung VO mit Durchgang PS16/PS16C-8, komplett, vorne oben sprühend Distributor deflection VO with pass PS16/PS16C-8, complete spraying front/above		
020.27 Artikelnr./ partno.800206		
Verteilerumlenkung VU mit Durchgang PS16/PS16C-8, komplett, vorne unten sprühend Distributor deflection VU with pass PS16/PS16C-8, complete spraying front/down		
020.28 Artikelnr./ partno.801123		
Verteilerschließplatte O PS16-8, komplett, ohne O-Ringe, mit Entlüftung Distributor cover above (without O-rings), PS16-8, complete		
020.29 Artikelnr./ partno.801125		
Verteilerschließplatte O PS16-6, komplett, ohne O-Ringe, mit Entlüftung Distributor upper cover (without O-rings), PS16-6, complete		
020.30 Artikelnr./ partno.801307		
Verteilerdistanzmodul 10mm PS16/PS16C-6, komplett Distribution distance module 10mm PS16/PS16C-6, complete		

Artikelgruppe 21 Zubehör prod.group 21 addons



Artikelgruppe 21 Zubehör
 prod.group 21 addons

021.1 Artikelnr./ partno.225169		
Verteilerleistenverschlußplatte PS16-6 Distribution strip cover plate PS16-6		
021.2 Artikelnr./ partno.301532		
Verteilerleistenverschlußplatte PS16-8 Distribution strip cover plate PS16-8		
021.3 Artikelnr./ partno.800643		
Verteilerleistenmodul PS16-6, komplett (drei Kreise pro Reihe) Distribution strip module PS16-6, (3 circuits in a row)		
021.4 Artikelnr./ partno.800644		
Verteilerleiste PS16-6, komplett (drei Kreise pro Reihe) distributionstrip PS16-6, (3 circuits in a row)		
021.5 Artikelnr./ partno.801229		
Verteilerleistenmodul PS16-8, komplett (drei Kreise pro Reihe) distribution strip module PS16-8, (3 circuits in a row)		







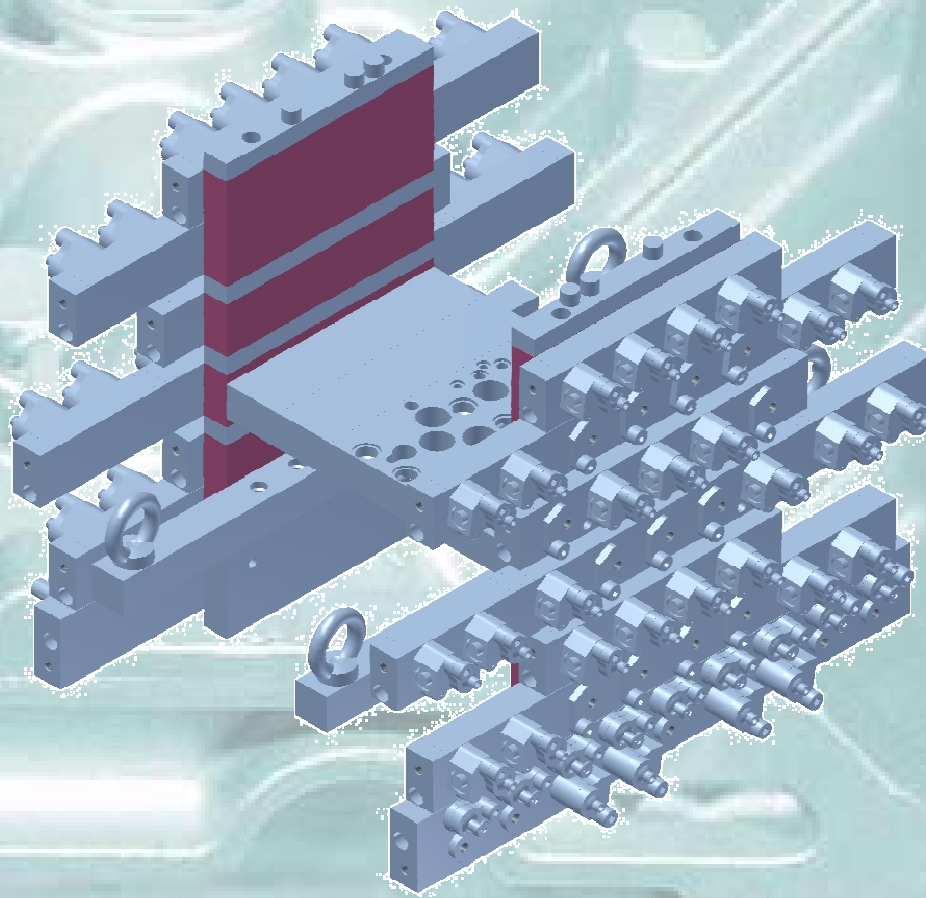



Artikelgruppe 021 Zubehör
prod.group 021 addons

021.6 Artikelnr./ partno.801231		
Verteilerleiste PS16-8, komplett (drei Kreise pro Reihe) distribution strip PS16-8, (3 circuits in a row)		

Artikelgruppe 22 Zubehör prod.group 22 addons



Artikelgruppe 22 Zubehör
 prod.group 22 addons

022.1 Artikelnr./ partno.308225		
Verteilerleistenverschlußplatte (kompakt) PS16C-6 Distribution strip cover plate PS16C-6		
022.2 Artikelnr./ partno.800210		
Verteilerleistenmodul (kompakt) PS16C-8, komplett Distribution strip module (compact) PS16C-8, complete		
022.3 Artikelnr./ partno.800212		
Verteilerleistenmodul (kompakt) PS16C-8, komplett, beidseitig Distribution strip module (compact) PS16C-8, complete, two-sided		
022.4 Artikelnr./ partno.800292		
Verteilerleiste (kompakt) PS16C-6, komplett Distribution strip (compact) PS16C-6, complete		
022.5 Artikelnr./ partno.800295		
Verteilerleistenmodul (kompakt) PS16C-6, komplett Distribution strip (compact) PS16C-6, complete		



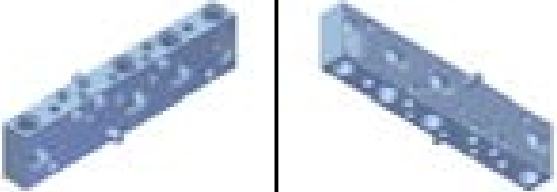
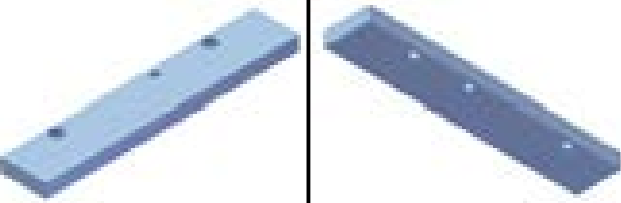



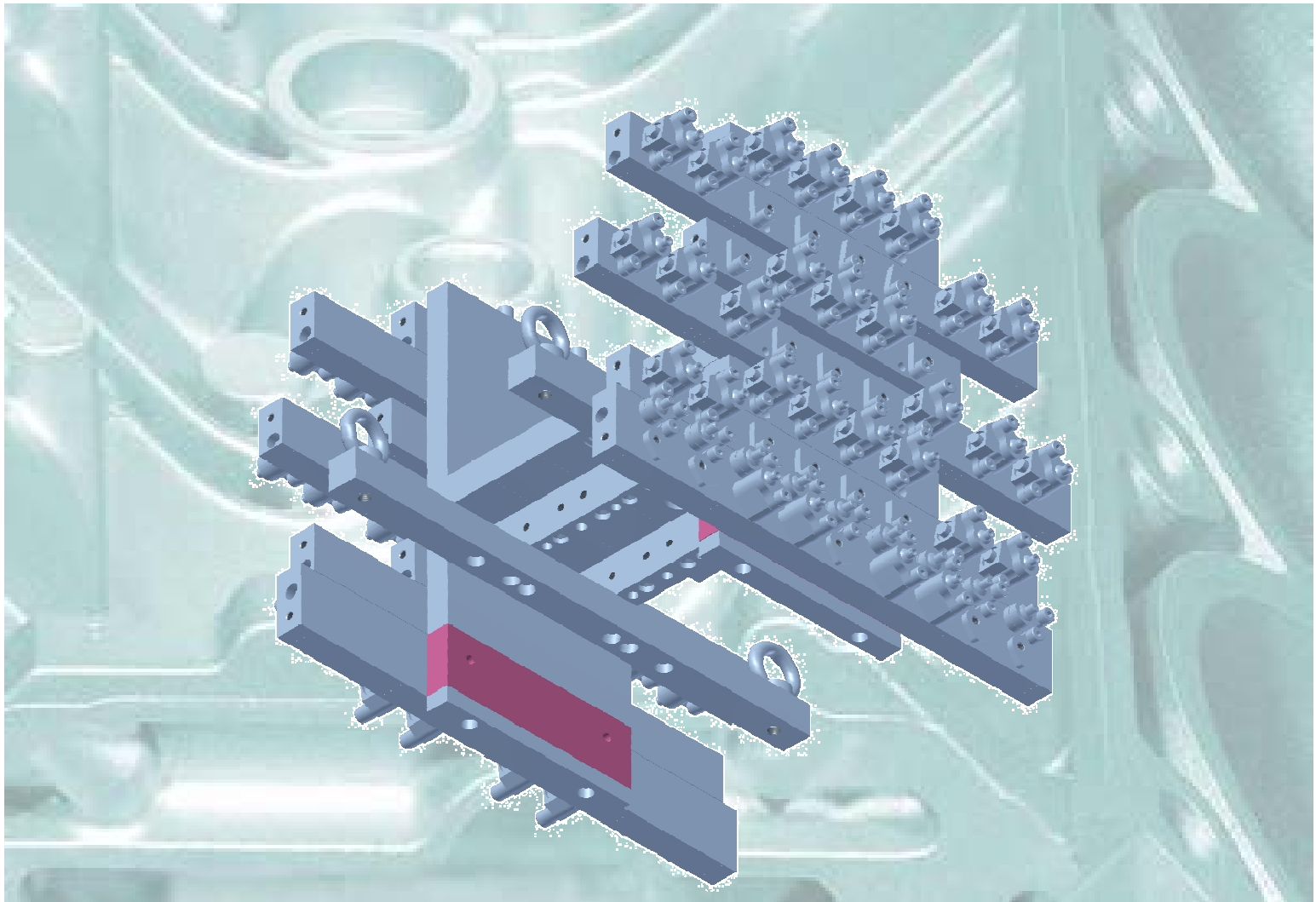



Artikelgruppe 22 Zubehör
prod.group 22 addons

022.6 Artikelnr./ partno.800298		
Verteilerleistenmodul (kompakt) PS16C-6, komplett, beidseitig Distribution strip module (compact) PS16C, complete, two-sided		
022.7 Artikelnr./ partno.801157		
Verteilerleistenverschußplatte (kompakt) PS16C-8 Distribution strip cover plate PS16C-8		









Artikelgruppe 23 Zubehör prod.group 23 addons



Artikelgruppe 23 Zubehör
prod.group 23 addons

023.1 Artikelnr./ partno.800024		
Verteilerleiste (kombi) PS16C-6, komplett Distribution strip (combi) PS16C-6, complete		
023.2 Artikelnr./ partno.800027		
Verteilerleiste (kombi) PS16C-8, komplett Distribution strip (combi) PS16C-8, complete		
023.3 Artikelnr./ partno.800050		
Verteilerleistenmodul (kombi) PS16C-6, komplett Distribution strip module (combi) PS16C-6, complete		
023.4 Artikelnr./ partno.800052		
Verteilerleistenmodul (kombi) PS16C-8, komplett distribution strip module 60 PS16C-8, komplett		
023.5 Artikelnr./ partno.800054		
Verteilerleistenmodul (kombi) PS16C-6, komplett, beidseitig Distribution strip module (combi) PS16C-6, two-sided, complete		







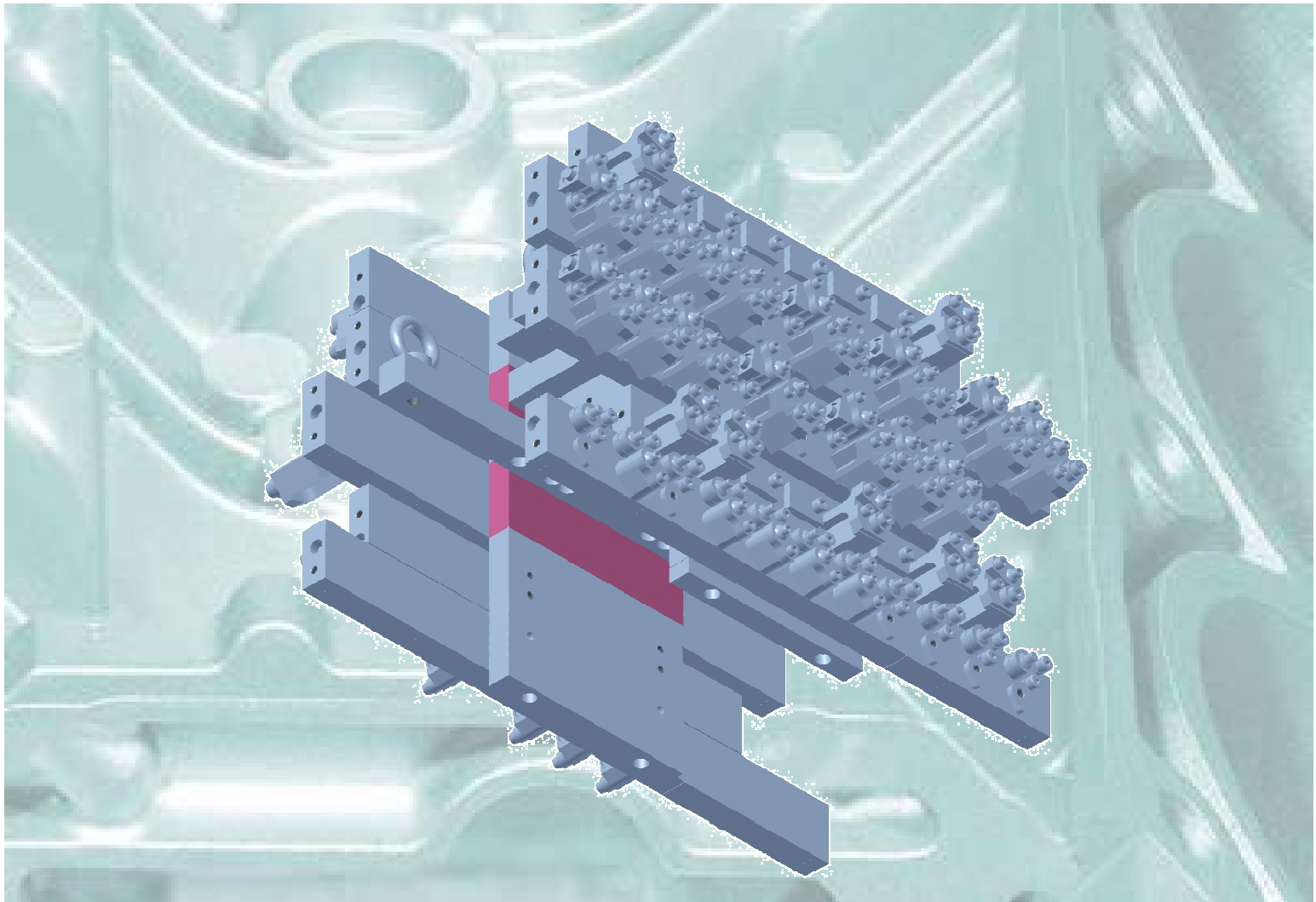

Artikelgruppe 23 Zubehör
 prod.group 23 addons

<p>023.6 Artikelnr./ partno.800056</p>		
<p>Verteilerleistenmodul (combi) PS16C-8, komplett, beidseitig Distribution strip module (combi) PS16C-8, complete, two-sided</p>		
<p>023.7 Artikelnr./ partno.800279</p>		
<p>Verteilerleistenverschußplatte (combi) PS16C-6 Distribution strip cover plate PS16C-6 (combi)</p>		
<p>023.8 Artikelnr./ partno.800767</p>		
<p>Verteilerleistenmodul (combi) PS16C-6, komplett, 180° gedreht Distribution strip module (combi) PS16C-6, complete, 180° twisted</p>		
<p>023.9 Artikelnr./ partno.801671</p>		
<p>Verteilerleistenmodul (combi) PS16C-8, komplett, 180° gedreht Distribution strip module (combi) PS16C-8, complete, 180° twisted</p>		

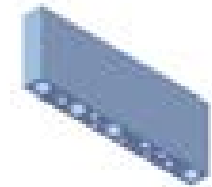

Artikelgruppe 24 Zubehör prod.group 24 addons

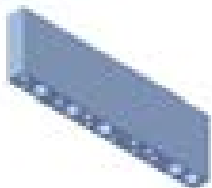

Artikelgruppe 24 Zubehör
prod.group 24 addons

024.1 Artikelnr./ partno.800039		
Verteilerleiste (doppelt) PS16C-8, komplett Distribution strip (double) PS16C-8, complete		
024.2 Artikelnr./ partno.800044		
Verteilerleiste (doppelt) PS16C-6, komplett Distribution strip (double) PS16C-6, complete		
024.3 Artikelnr./ partno.800046		
Verteilerleistenmodul (doppelt) PS16C-6, komplett Distribution strip module (double) PS16C-6, complete		
024.4 Artikelnr./ partno.800048		
Verteilerleistenmodul (doppelt) PS16C-8, komplett Distribution strip module (double)		
024.5 Artikelnr./ partno.800058		
Verteilerleistenmodul (doppelt) PS16C-8, komplett, beidseitig Distribution strip module (double) PS16C-8, complete, two-sided		







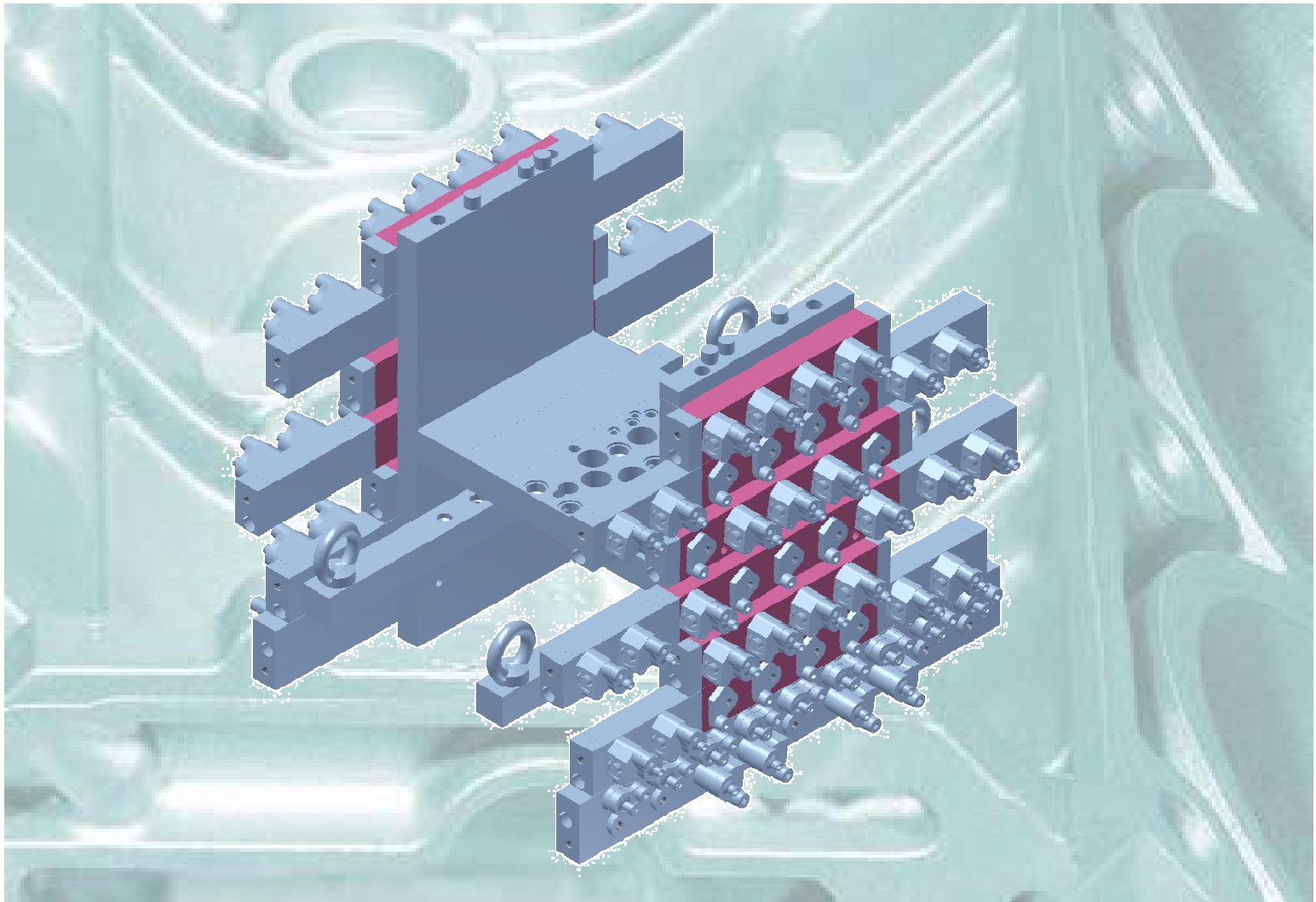



Artikelgruppe 024 Zubehör
prod.group 024 addons

024.6 Artikelnr./ partno.800060		
Verteilerleistenmodul (doppelt) PS16C-6, komplett, beidseitig Distribution strip module (double) PS16C-6, complete, two-sided		

Artikelgruppe 31 Zubehör prod.group 31 addons



Artikelgruppe 31 Zubehör
 prod.group 31 addons

031.1 Artikelnr./ partno.800001		
Kompaktsprühleiste 250mm Kreis 1/2 PS16C-6/8, komplett Combi spray strip module 50mm PS16C, complete		
031.2 Artikelnr./ partno.800029		
Kompaktsprühleiste 250mm Kreis 3/4 PS16C-6/8, komplett Compact spray strip 250mm circuit 3/4 PS16C-6/8, complete		
031.3 Artikelnr./ partno.800031		
Kompaktsprühleiste 250mm Kreis 5/6 PS16C-6/8, komplett Compact spray strip 250mm circuit 5/6 PS16C-6/8, complete		
031.4 Artikelnr./ partno.800208		
Kompaktsprühleiste 250mm Kreis 7/8 PS16C-8, komplett Compact spray strip 250mm circuit 7/8 PS16C-8, complete		
031.5 Artikelnr./ partno.800658		
Kompaktsprühleiste 200mm Kreis 1/2 PS16C-6, komplett Compact spray strip 200mm circuit 1/2 PS16C-6, complete		







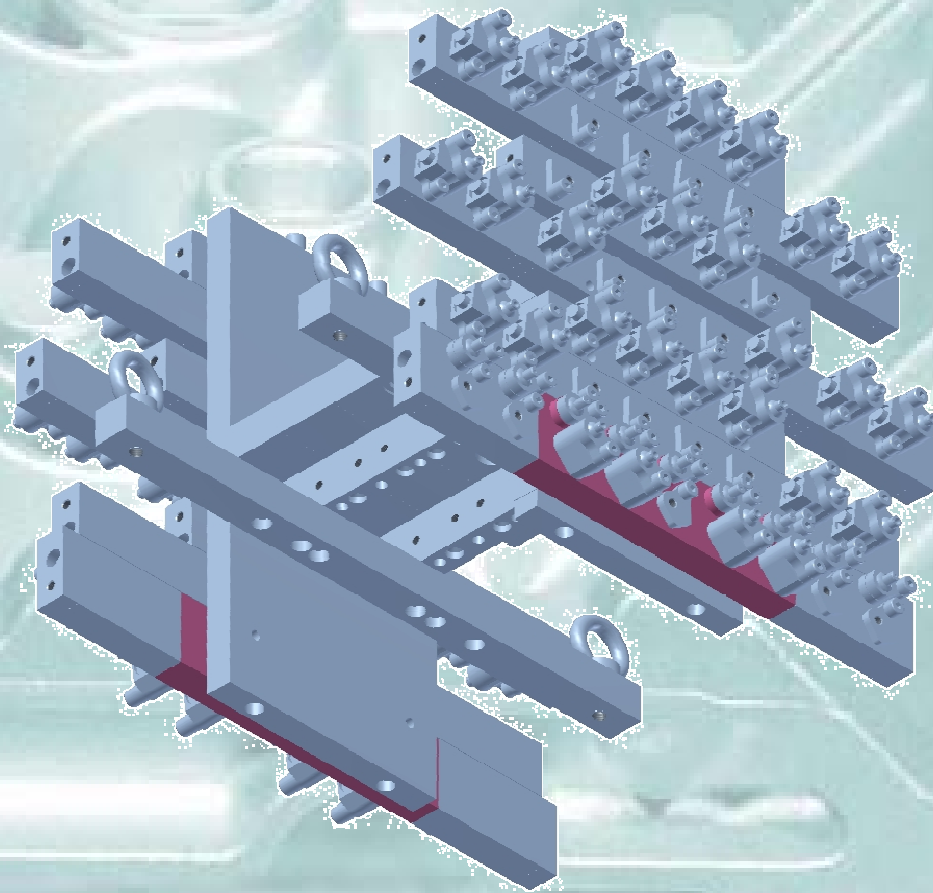



Artikelgruppe 31 Zubehör
 prod.group 31 addons

031.6 Artikelnr./ partno.800660		
Kompaktsprühleiste 200mm Kreis 3/4 PS16C-6, komplett Compact spray strip 200mm circuit 3/4 PS16C-6, complete		
031.7 Artikelnr./ partno.800662		
Kompaktsprühleiste 200mm Kreis 5/6 PS16C-6, komplett Compact spray strip 200mm circuit 5/6 PS16C-6, complete		
031.8 Artikelnr./ partno.801766		
Kompaktsprühleiste 170mm Kreis 1/2 PS16C-6/8, komplett Compact spray strip 170mm circuit 1/2 PS16C-6/8, complete		



Artikelgruppe 32 Zubehör prod.group 32 addons



Artikelgruppe 32 Zubehör
 prod.group 32 addons

032.1 Artikelnr./ partno.800003		
<p>Kombisprühleiste 250mm Kreis 1/2 PS16C-6/8, komplett Combi spray strip 250mm circuit 1/2 PS16C-6/8, complete</p>		
032.2 Artikelnr./ partno.800018		
<p>Kombisprühleiste 250mm Kreis 3/4 PS16C-6/8, komplett Combi spray strip 250mm circuit 3/4 PS16C-6/8, complete</p>		
032.3 Artikelnr./ partno.800020		
<p>Kombisprühleiste 250mm Kreis 5/6 PS16C-6/8, komplett Combi spray strip 250mm circuit 5/6 PS16C-6/8, complete</p>		
032.4 Artikelnr./ partno.800022		
<p>Kombisprühleiste 250mm Kreis 7/8 PS16C-8, komplett Combi spray strip 250mm circuit 7/8 PS16C-8, complete</p>		
032.5 Artikelnr./ partno.800769		
<p>Kombisprühleiste 250mm Kreis 1/2 PS16C-6/8, komplett, 180° gedreht Combi spray strip 250mm circuit 1/2 PS16C-6/8, complete, 180° twisted</p>		







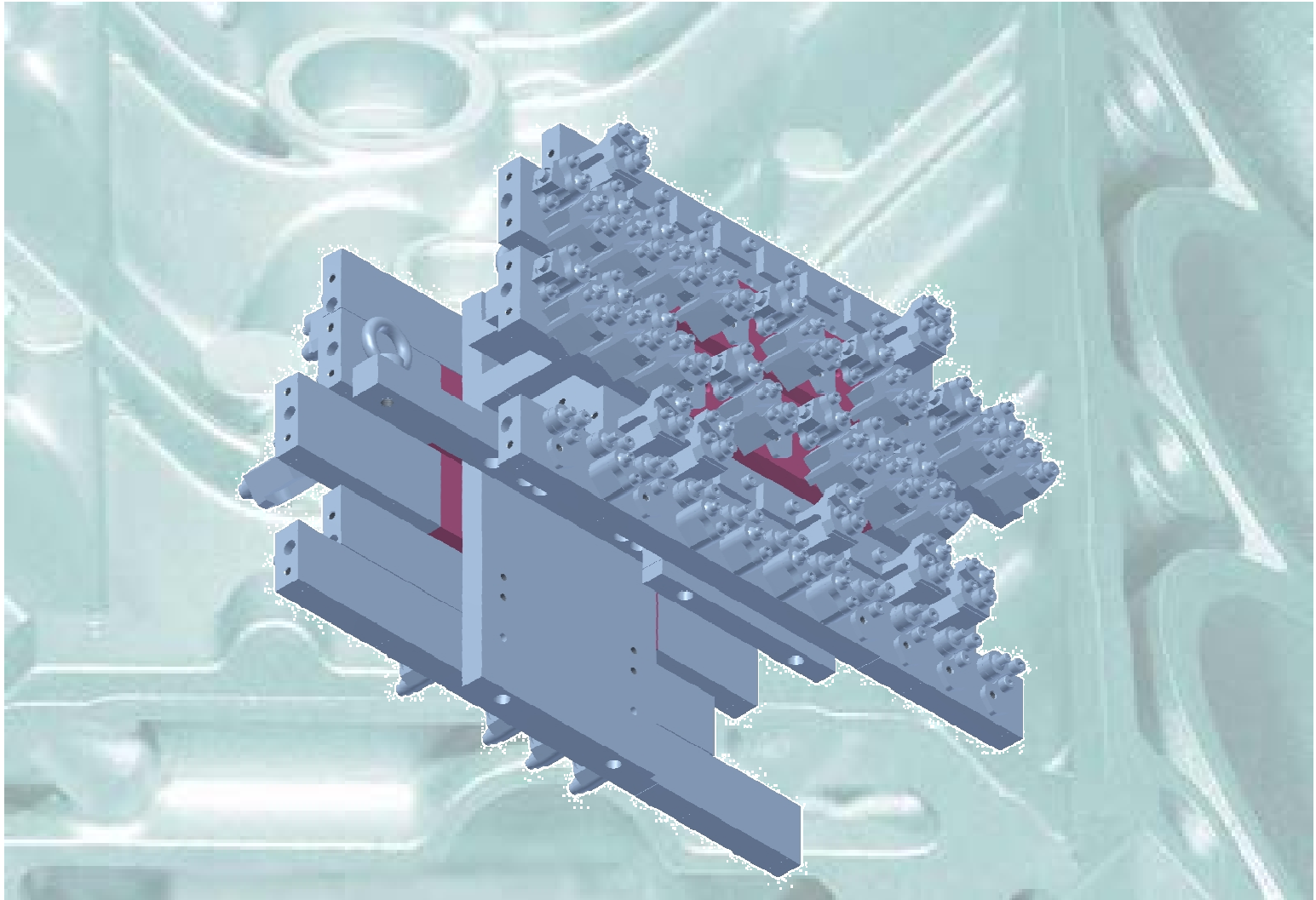



Artikelgruppe 032 Zubehör
prod.group 032 addons

032.6 Artikelnr./ partno.800771		
Kombisprühleiste 250mm Kreis 3/4 PS16C-6/8, komplett, 180° gedreht Combi spray strip 250mm circuit 3/4 PS16C-6/8, complete, 180° twisted		







Artikelgruppe 33 Zubehör prod.group 33 addons



Artikelgruppe 33 Zubehör
 prod.group 33 addons

033.1 Artikelnr./ partno.800005		
<p>Doppelsprühleiste 250mm Kreis 1/2-Kreis 3/4 PS16C-6/8, komplett</p> <p>Double spray strip 250mm circuit 1/2-circuit 3/4 PS16C-6/8, complete</p>		
033.2 Artikelnr./ partno.800016		
<p>Doppelsprühleiste 250mm Kreis 1/2-Kreis 5/6 PS16C-6/8, komplett</p> <p>Double spray strip 250mm circuit 1/2-circuit 5/6 PS16C-6/8, complete</p>		
033.3 Artikelnr./ partno.800033		
<p>Doppelsprühleiste 250mm Kreis 1/2-Kreis 7/8 PS16C-8, komplett</p> <p>Double spray strip 250mm circuit 1/2-circuit 7/8 PS16C-8, complete</p>		
033.4 Artikelnr./ partno.800035		
<p>Doppelsprühleiste 250mm Kreis 3/4-Kreis 5/6 PS16C-6/8, komplett</p> <p>Double spray strip 250mm circuit 3/4-circuit 5/6 PS16C-6/8, complete</p>		
033.5 Artikelnr./ partno.800037		
<p>Doppelsprühleiste 250mm Kreis 3/4-Kreis 7/8 PS16C-8, komplett</p> <p>Double spray strip 250mm circuit 3/4-circuit 7/8 PS16C-8, complete</p>		



Artikelgruppe 33 Zubehör
 prod.group 33 addons

033.6 Artikelnr./ partno.800284		
Doppelsprühleiste 250mm Kreis 5/6-Kreis 7/8 PS16C-8, komplett Double spray strip 250mm circuit 5/6-circuit 7/8 PS16C-8, complete		
033.7 Artikelnr./ partno.800846		
Doppelsprühleiste 250mm Kreis 3/4-Kreis 1/2 PS16C-6/8, komplett Double spray strip 250mm circuit 3/4-circuit 1/2 PS16C-6/8, complete		
033.8 Artikelnr./ partno.801523		
Doppelsprühleiste 250mm Kreis 7/8-Kreis 5/6 PS16C-8, komplett Double spray strip 250mm circuit 5/6-circuit 7/8 PS16C-8, complete		

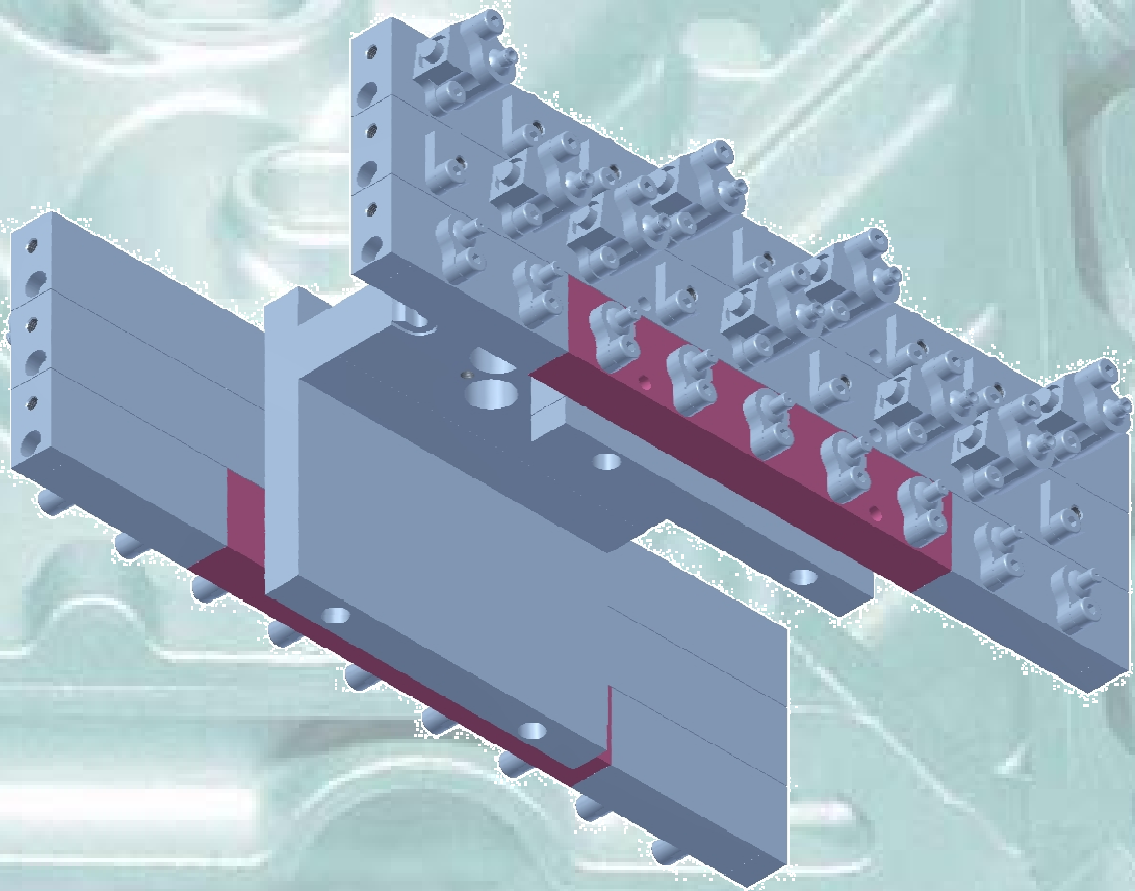
Artikelgruppe 34 Zubehör prod.group 34 addons









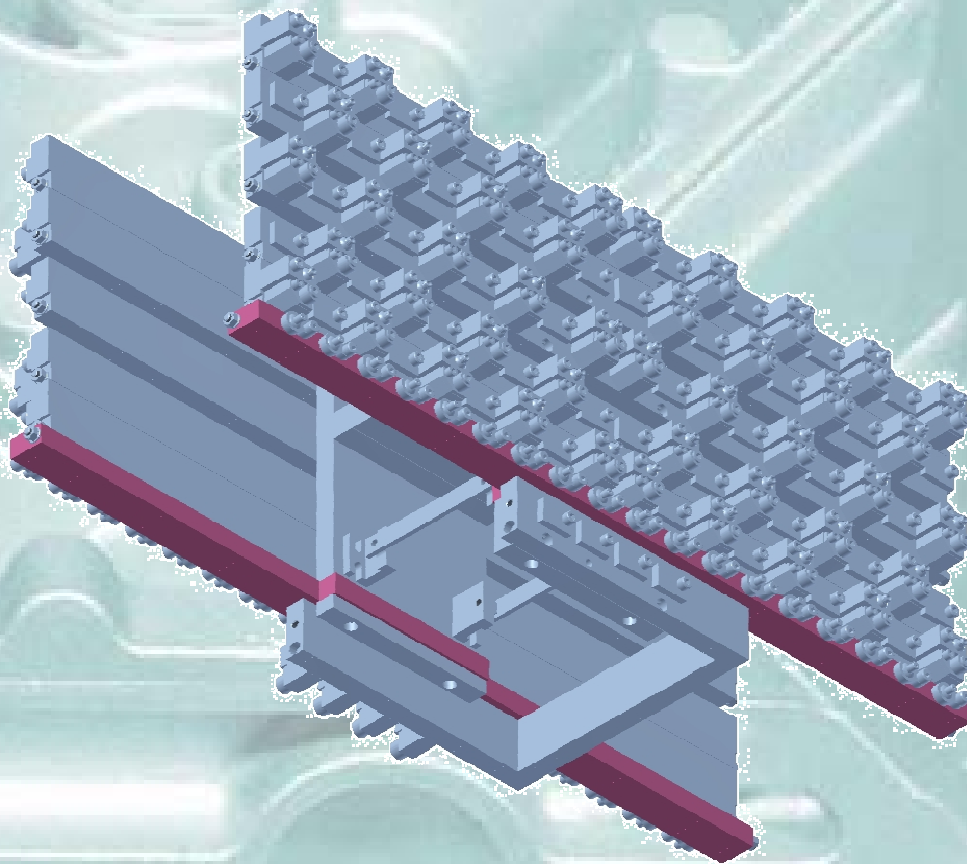



Artikelgruppe 34 Zubehör
prod.group 34 addons

034.1 Artikelnr./ partno.800300		
Blasleiste 250mm PS16C-6/8, komplett Blasting strip 250mm PS16C, complete		











Artikelgruppe 35 Zubehör prod.group 35 addons













Artikelgruppe 35 Zubehör
 prod.group 35 addons

<p>035.1 Artikelnr./ partno.800989</p>		
<p>Verteilerblasleiste 23mm PS16-6/PS16C-6, komplett Distribution blasting strip 23mm PS16-6/PS16C-6, complete</p>		
<p>035.2 Artikelnr./ partno.800990</p>		
<p>Verteilerblasschliessleiste L PS16/PS16C, komplett Distribution blasting strip cover left PS16/PS16C</p>		
<p>035.3 Artikelnr./ partno.800992</p>		
<p>Verteilerblasschliessleiste R PS16/PS16C, komplett Distribution blasting strip cover right PS16/PS16C, complete</p>		
<p>035.4 Artikelnr./ partno.800994</p>		
<p>Blasleistenmodul 50mm PS16/PS16C, komplett Blasting strip module 50mm PS16/PS16C, complete</p>		
<p>035.5 Artikelnr./ partno.800996</p>		
<p>Blasleistenmodul 100mm PS16/PS16C, komplett Blasting strip module 100mm PS16/PS16C, complete</p>		

Artikelgruppe 35 Zubehör
 prod.group 35 addons

<p>035.6 Artikelnr./ partno.801008</p>		
<p>Verteilerblasleiste 23mm PS16-6/PS16C-6, komplett, ohne Schließleiste Distribution blasting strip 23mm PS16-6/PS16C-6, complete, without cover</p>		
<p>035.7 Artikelnr./ partno.801031</p>		
<p>Verteilerblasleiste 23mm PS16-8/PS16C-8, komplett Distribution blasting strip 23mm PS16-8/PS16C-8, complete</p>		
<p>035.8 Artikelnr./ partno.801365</p>		
<p>Verteilerblasleiste 23mm PS16-8/PS16C-8, komplett, ohne Schließleiste unten Distribution blasting strip 23mm PS16-8/PS16C-8, complete, without cover</p>		
<p>035.9 Artikelnr./ partno.801559</p>		
<p>Blasabschlußleiste 50mm links PS16/PS16C, komplett Left end blasting strip module 50mm PS16/PS16C, complete</p>		
<p>035.10 Artikelnr./ partno.801647</p>		
<p>Verteilerblasleiste 23mm PS16-8/PS16C-8, komplett, ohne Schließleiste oben Distribution blasting strip 23mm PS16-8/PS16C-8, complete, without cover</p>		

Artikelgruppe 35 Zubehör
 prod.group 35 addons

035.11 Artikelnr./ partno.801665		
Blasleistenumlenkung mit Durchgang PS16/PS16C, komplett, nach oben Blasting strip deflection with pass PS16/PS16C, complete		
035.12 Artikelnr./ partno.801697		
Blasabschlußleiste 50mm rechts PS16/PS16C, komplett Right end blasting strip module 50mm PS16/PS16C, complete		
035.13 Artikelnr./ partno.801742		
Blasleistendistanzmodul 15mm PS16/PS16C, komplett		
035.14 Artikelnr./ partno.801759		
Verteilerblasleiste 23mm PS25-8, komplett, ohne Schließleiste unten Distribution blasting strip 23mm PS25-8, complete, without cover		
035.15 Artikelnr./ partno.801761		
Verteilerblasleiste 23mm PS25-8, komplett, ohne Schließleiste oben Distribution blasting strip 23mm PS25-8, complete, without cover		

Artikelgruppe 40 Zubehör prod.group 40 addons

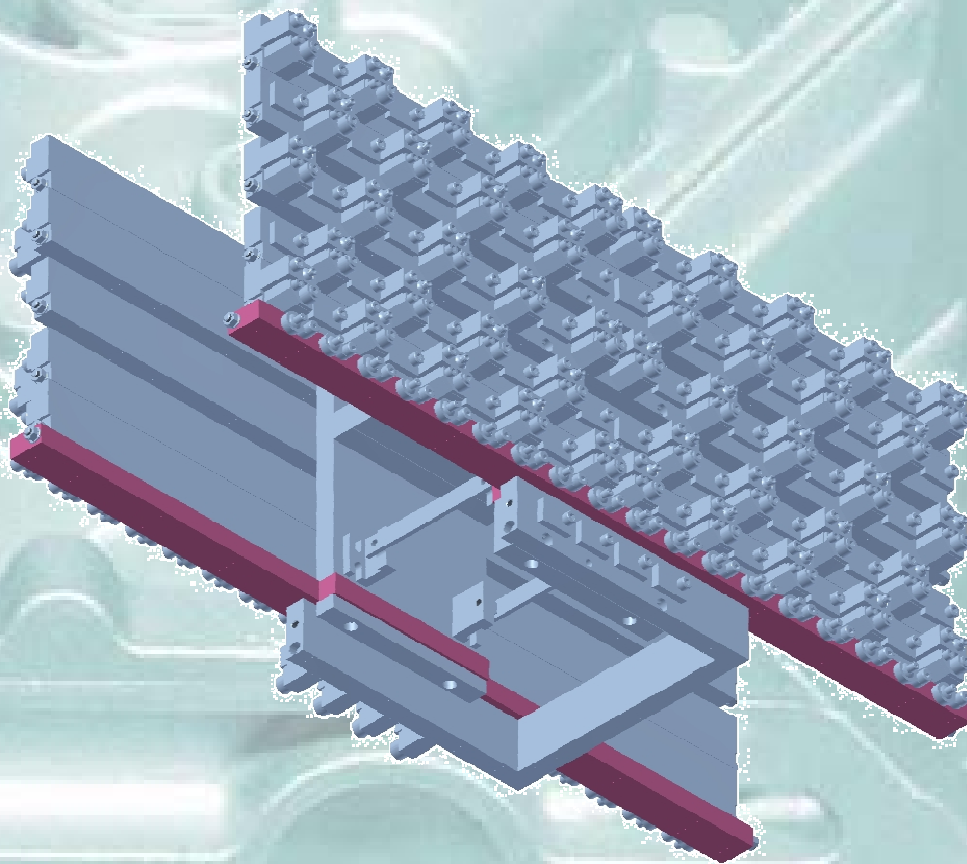







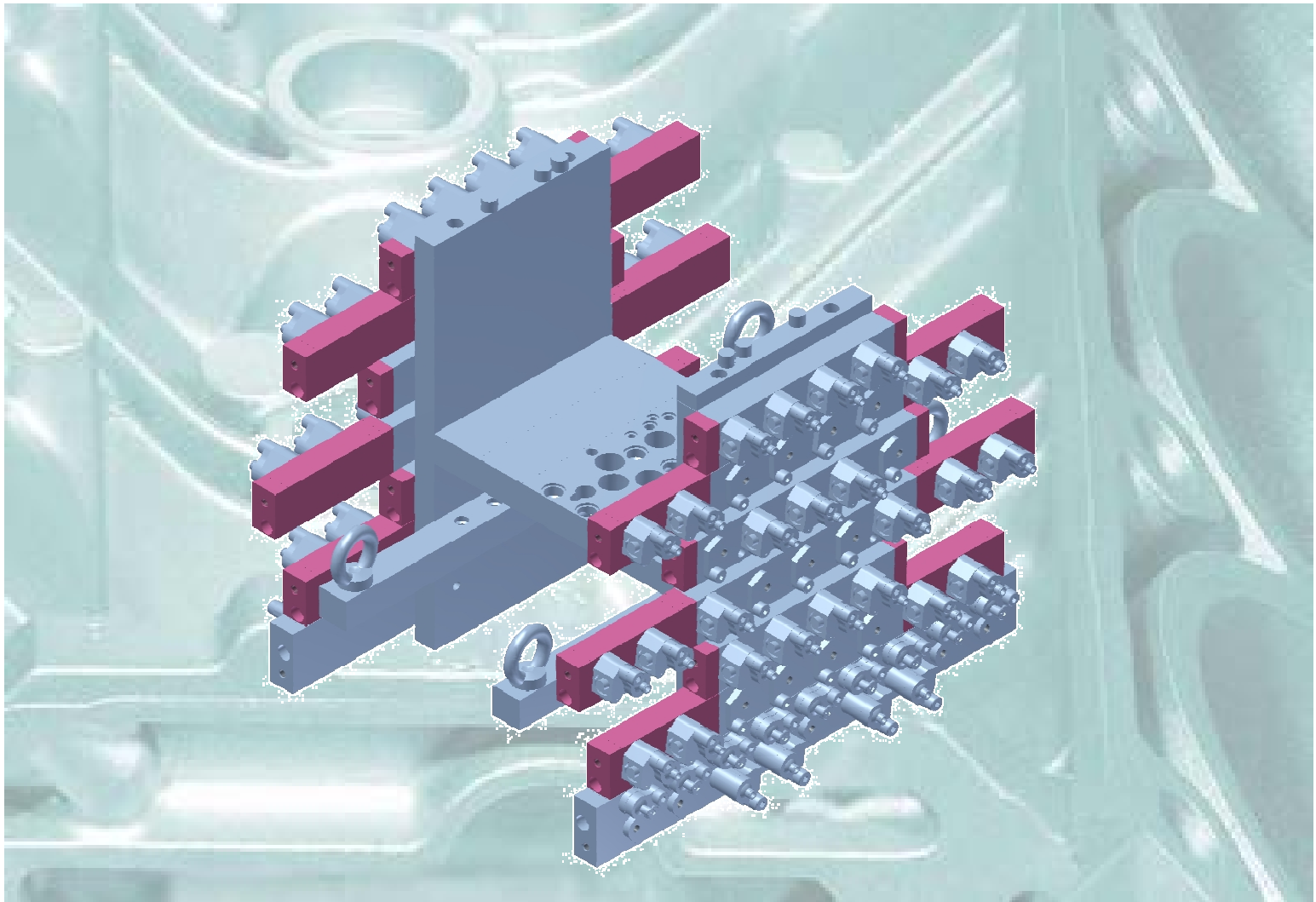



Artikelgruppe 40 Zubehör
prod.group 40 addons

040.1 Artikelnr./ partno.250555		
Sprüh-/Blasleistenmodul 50mm PS16, komplett Spray and blasting strip modul 50mm PS16, complete		











Artikelgruppe 41 Zubehör prod.group 41 addons













Artikelgruppe 41 Zubehör
 prod.group 41 addons

041.1 Artikelnr./ partno.800062		
Kompaktsprühleistenmodul 100mm PS16C, komplett Compact spray strip module 100mm PS16C, complete		
041.2 Artikelnr./ partno.800076		
Kompaktsprühleistenschliessleiste R PS16C, komplett, mit O-Ringen Cover for compact spray strip R PS16C, complete, with o-rings		
041.3 Artikelnr./ partno.800077		
Kompaktsprühleistenschliessleiste L PS16C, komplett, ohne O-Ringe Cover for compact spray strip L PS16C, complete, without o-rings		
041.4 Artikelnr./ partno.800081		
Kompaktsprühleistenmodul 50mm PS16C, komplett Compact spray strip module 50mm PS16C, complete		
041.5 Artikelnr./ partno.800092		
Kompaktsprühleistenkreuzung PS16C, komplett Compact spray strip junction PS16C, complete		











Artikelgruppe 41 Zubehör
 prod.group 41 addons

041.6 Artikelnr./ partno.800116		
Kompaktsprühleistenwinkel 1 PS16C, komplett Angle 1 for compact spray strips PS16C, complete		
041.7 Artikelnr./ partno.800118		
Kompaktsprühleistenwinkel 2 PS16C, komplett Angle 2 for compact spray strips PS16C, complete		
041.8 Artikelnr./ partno.800120		
Kompaktsprühleistenwinkel 3 PS16C, komplett Angle 3 for compact spray strips PS16C, complete		
041.9 Artikelnr./ partno.800122		
Kompaktsprühleistenwinkel 4 PS16C, komplett Angle 4 for compact spray strips PS16C, complete		
041.10 Artikelnr./ partno.800141		
Kompaktsprühleistendistanzmodul 100mm PS16C, komplett Compact spray strip spacer modul 100mm PS16C, complete		



Artikelgruppe 41 Zubehör
 prod.group 41 addons

041.11 Artikelnr./ partno.800143		
<p>Kompaktsprühleistendistanzmodul 50mm PS16C, komplett Compact spray strip spacer modul 50mm PS16C, complete</p>		
041.12 Artikelnr./ partno.800326		
<p>Kompaktsprühleistenwinkelstück 45°LHA PS16C, komplett, links hinten außensprühend Compact spray strip angled piece 45°LHA PS16C, complete, spraying left, rear, outside</p>		
041.13 Artikelnr./ partno.800328		
<p>Kompaktsprühleistenwinkelstück 45°LVI PS16C, komplett, links vorne innensprühend Compact spray strip angled piece 45°LVI PS16C, complete, spraying left, front, inside</p>		
041.14 Artikelnr./ partno.800330		
<p>Kompaktsprühleistenwinkelstück 45°RHA PS16C, komplett, rechts hinten außensprühend Compact spray strip angled piece 45°RHA PS16C, complete, spraying right, rear, outside</p>		
041.15 Artikelnr./ partno.800332		
<p>Kompaktsprühleistenwinkelstück 45°RVI PS16C, komplett, rechts vorne innensprühend Compact spray strip angled piece 45°RVI PS16C, complete, spraying right, front, inside</p>		

Artikelgruppe 41 Zubehör
 prod.group 41 addons

<p>041.16 Artikelnr./ partno.800354</p>		
<p>Kompaktsprühleistendistanzmodul 10mm PS16C, komplett Compact spray strip spacer module 10mm PS16C, complete</p>		
<p>041.17 Artikelnr./ partno.800369</p>		
<p>Kompaktsprühleisten-Inversmodul o.O-R PS16C, komplett Compact spray strip inverse module PS16C, complete, without o-rings</p>		
<p>041.18 Artikelnr./ partno.800371</p>		
<p>Kompaktsprühleisten-Inversmodul m.O-R PS16C, komplett Compact spray strip inverse module PS16C, complete, with o-rings</p>		
<p>041.19 Artikelnr./ partno.801617</p>		
<p>Kompaktsprühleistendistanzmodul 15mm PS16C, komplett Compact spray strip spacer module 10mm PS16C, complete</p>		
<p>041.20 Artikelnr./ partno.801737</p>		
<p>Kompaktsprühabschlußleiste 50mm rechts PS16C, komplett Right end compact spray strip module 50mm PS16C, complete</p>		







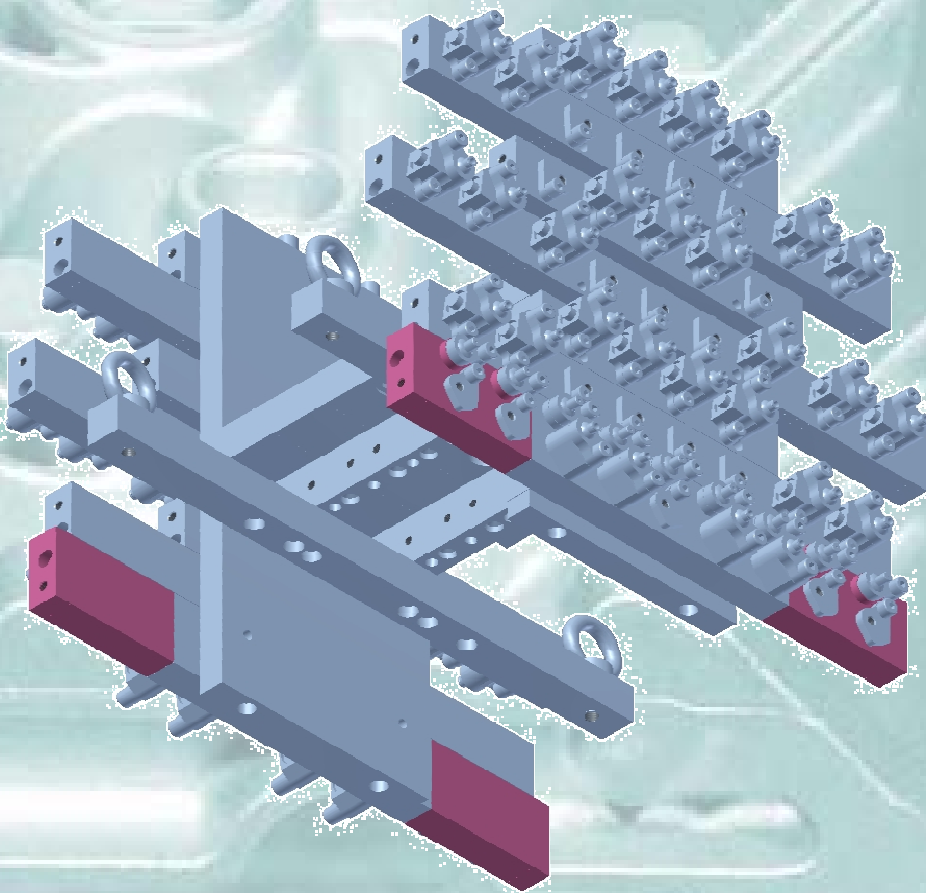

Artikelgruppe 041 Zubehör
prod.group 041 addons

041.21 Artikelnr./ partno.801744		
Kompaktsprühabschlußleiste 50mm links PS16C, komplett Left end compact spray strip module 50mm PS16C, complete		

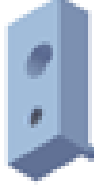

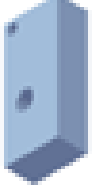







Artikelgruppe 42 Zubehör prod.group 42 addons











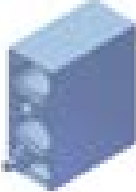

Artikelgruppe 42 Zubehör
 prod.group 42 addons

<p>042.1 Artikelnr./ partno.800066</p> <p>Kombisprühleistenmodul 100mm PS16C, komplett</p> <p>Combi spray strip module 100mm PS16C, complete</p>		
<p>042.2 Artikelnr./ partno.800073</p> <p>Kombisprühleistenschliessleiste R PS16C, komplett, mit O-Ringen</p> <p>Cover for combi spray strip R PS16C, complete, with o-rings</p>		
<p>042.3 Artikelnr./ partno.800074</p> <p>Kombisprühleistenschliessleiste L PS16C, komplett, ohne O-Ringe</p> <p>Cover for combi spray strip L PS16C, complete, without o-rings</p>		
<p>042.4 Artikelnr./ partno.800085</p> <p>Kombisprühleistenmodul 50mm PS16C, komplett</p> <p>Combi spray strip module 50mm PS16C, complete</p>		
<p>042.5 Artikelnr./ partno.800096</p> <p>Kombisprühleistenkreuzung PS16C, komplett</p> <p>Combi spray strip junction PS16C, complete</p>		











Artikelgruppe 42 Zubehör
 prod.group 42 addons

042.6 Artikelnr./ partno.800108		
Kombisprühleistenwinkel 1 PS16C, komplett Angle 1 for combi spray strips PS16C, complete		
042.7 Artikelnr./ partno.800110		
Kombisprühleistenwinkel 2 PS16C, komplett Angle 2 for combi spray strips PS16C, complete		
042.8 Artikelnr./ partno.800112		
Kombisprühleistenwinkel 3 PS16C, komplett Angle 3 for combi spray strips PS16C, complete		
042.9 Artikelnr./ partno.800114		
Kombisprühleistenwinkel 4 PS16C, komplett Angle 4 for combi spray strips PS16C, complete		
042.10 Artikelnr./ partno.800145		
Kombisprühleistendistanzmodul 100mm PS16C, komplett Combi spray strip spacer module 100mm PS16C, complete		



Artikelgruppe 42 Zubehör
 prod.group 42 addons

<p>042.11 Artikelnr./ partno.800147</p>		
<p>Kombisprühleistendistanzmodul 50mm PS16C, komplett Combi spray strip spacer module 50mm PS16C, complete</p>		
<p>042.12 Artikelnr./ partno.800318</p>		
<p>Kombisprühleistenwinkelstück 45°LHA PS16C, komplett, links hinten außensprühend Combi spray strip angled piece 45°LHA PS16C, complete, spraying left, rear, outside</p>		
<p>042.13 Artikelnr./ partno.800320</p>		
<p>Kombisprühleistenwinkelstück 45°LVI PS16C, komplett, links vorne innensprühend Combi spray strip angled piece 45°LVI PS16C, complete, spraying left, front, inside</p>		
<p>042.14 Artikelnr./ partno.800322</p>		
<p>Kombisprühleistenwinkelstück 45°RHA PS16C, komplett, rechts hinten außensprühend Combi spray strip angled piece 45°RHA PS16C, complete, spraying right, rear, outside</p>		
<p>042.15 Artikelnr./ partno.800324</p>		
<p>Kombisprühleistenwinkelstück 45°RVI PS16C, komplett, rechts vorne innensprühend Combi spray strip angled piece 45°RVI PS16C, complete, spraying right, front, inside</p>		

Artikelgruppe 42 Zubehör
 prod.group 42 addons

<p>042.16 Artikelnr./ partno.800358</p> <p>Kombisprühleistendistanzmodul 10mm PS16C, komplett</p> <p>Combi spray strip spacer module 10mm PS16C, complete</p>		
<p>042.17 Artikelnr./ partno.800373</p> <p>Kombisprühleisten-Inversmodul o.O-R PS16C, komplett</p> <p>Combi spray strip inverse module PS16C, complete, without o-rings</p>		
<p>042.18 Artikelnr./ partno.800375</p> <p>Kombisprühleisten-Inversmodul m.O-R PS16C, komplett</p> <p>Combi spray strip inverse module PS16C, complete, with o-rings</p>		
<p>042.19 Artikelnr./ partno.801438</p> <p>Kombisprühabschlußleiste 50mm rechts PS16C, komplett</p> <p>Right end combispray strip module 50mm PS16C, complete</p>		
<p>042.20 Artikelnr./ partno.801440</p> <p>Kombisprühabschlußleiste 50mm links PS16C, komplett</p> <p>Left end combispray strip module 50mm PS16C, complete</p>		







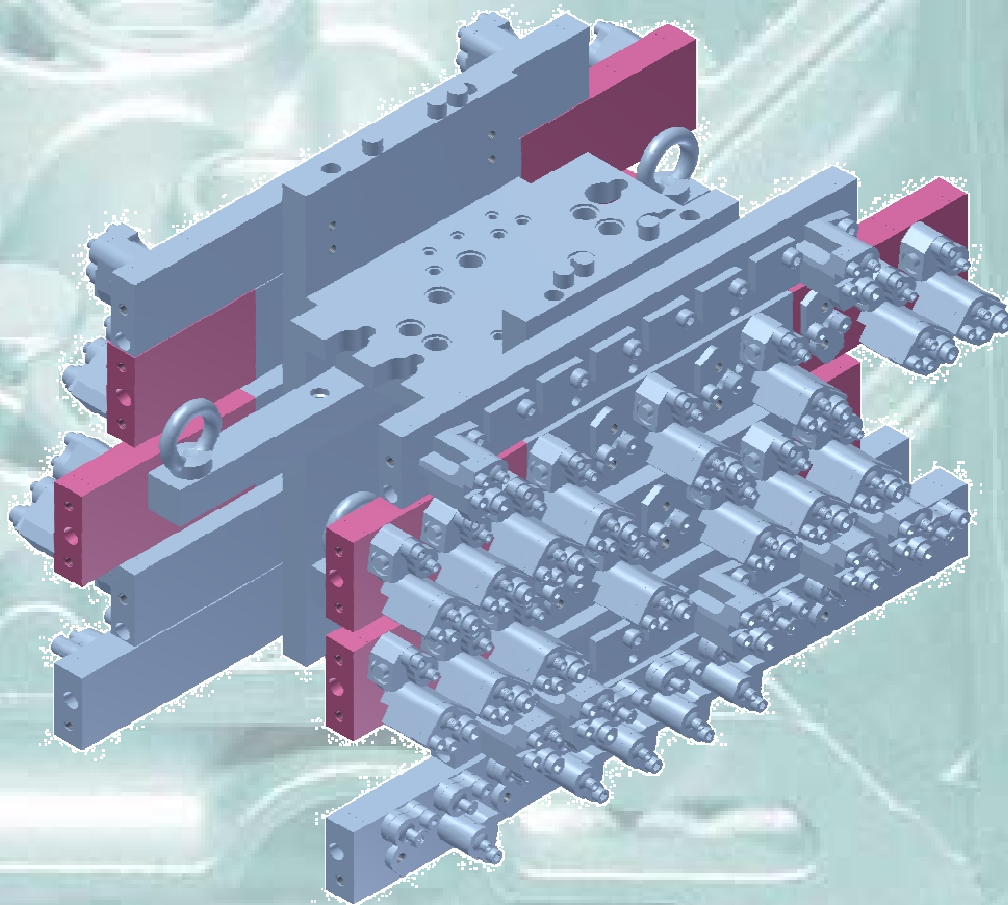

Artikelgruppe 042 Zubehör
prod.group 042 addons

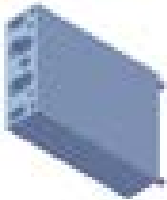
042.21 Artikelnr./ partno.801792		
Kombisprühleistenmodul 50mm PS16C, komplett, beidseitig Combi spray strip module 50mm PS16C, complete		



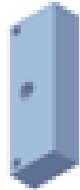





Artikelgruppe 43 Zubehör prod.group 43 addons







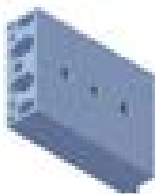



Artikelgruppe 43 Zubehör
 prod.group 43 addons

<p>043.1 Artikelnr./ partno.800068</p> <p>Doppelsprühleistenmodul 100mm PS16C, komplett</p> <p>Double spray strip module 100mm PS16C, complete</p>		
<p>043.2 Artikelnr./ partno.800070</p> <p>Doppelsprühleistenschliessleiste R PS16C, komplett, mit O-Ringen</p> <p>Cover for double spray strip R PS16C, complete, with o-rings</p>		
<p>043.3 Artikelnr./ partno.800071</p> <p>Doppelsprühleistenschliessleiste L PS16C, komplett, ohne O-Ringe</p> <p>Cover for double spray strip L PS16C, complete, without o-rings</p>		
<p>043.4 Artikelnr./ partno.800087</p> <p>Doppelsprühleistenmodul 50mm PS16C, komplett</p> <p>Double spray strip module 50mm PS16C, complete</p>		
<p>043.5 Artikelnr./ partno.800100</p> <p>Doppelsprühleistenwinkel 1 PS16C, komplett</p> <p>Angle 1 for double spray strips PS16C, complete</p>		

Artikelgruppe 43 Zubehör
 prod.group 43 addons

043.6 Artikelnr./ partno.800102		
Doppelsprühleistenwinkel 2 PS16C, komplett Angle 2 for double spray strips PS16C, complete		
043.7 Artikelnr./ partno.800104		
Doppelsprühleistenwinkel 3 PS16C, komplett Angle 3 for double spray strips PS16C, complete		
043.8 Artikelnr./ partno.800106		
Doppelsprühleistenwinkel 4 PS16C, komplett Angle 4 for double spray strips PS16C, complete		
043.9 Artikelnr./ partno.800149		
Doppelsprühleistendistanzmodul 100mm PS16C, komplett Double spray strip spacer modul 100mm PS16C, complete		
043.10 Artikelnr./ partno.800151		
Doppelsprühleistendistanzmodul 50mm PS16C, komplett Double spray strip spacer module 50mm PS16C, complete		

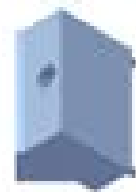
Artikelgruppe 43 Zubehör
 prod.group 43 addons

<p>043.11 Artikelnr./ partno.800310</p> <p>Doppelsprühleistenwinkelstück 45°LHA PS16C, komplett, links hinten außensprühend</p> <p>Double spray strip angled piece 45°LHA PS16C, complete, spraying left, rear, outside</p>		
<p>043.12 Artikelnr./ partno.800312</p> <p>Doppelsprühleistenwinkelstück 45°LVI PS16C, komplett, links vorne innensprühend</p> <p>Double spray strip angled piece 45°LVI PS16C, complete, spraying left, front, inside</p>		
<p>043.13 Artikelnr./ partno.800314</p> <p>Doppelsprühleistenwinkelstück 45°RHA PS16C, komplett, rechts hinten außensprühend</p> <p>Double spray strip angled piece 45°RHA PS16C, complete, spraying right, rear, outside</p>		
<p>043.14 Artikelnr./ partno.800316</p> <p>Doppelsprühleistenwinkelstück 45°RVI PS16C, komplett, rechts vorne innensprühend</p> <p>Double spray strip angled piece 45°RVI PS16C, complete, spraying right, front, inside</p>		
<p>043.15 Artikelnr./ partno.800360</p> <p>Doppelsprühleistendistanzmodul 10mm PS16C, komplett</p> <p>Double spray strip spacer module 10mm PS16C, complete</p>		







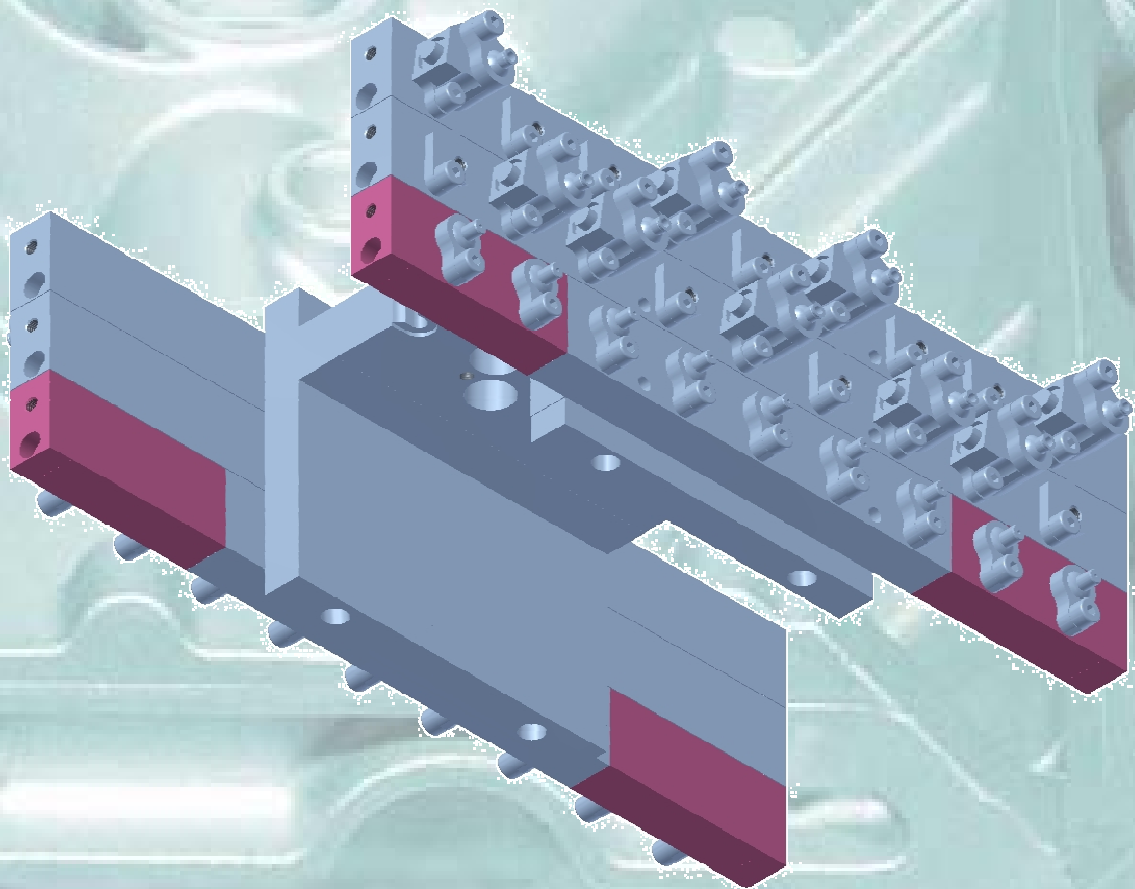



Artikelgruppe 043 Zubehör
prod.group 043 addons

043.16 Artikelnr./ partno.800377		
Doppelsprühleisten-Inversmodul PS16C, komplett Double spray strip inverse module PS16C, complete		











Artikelgruppe 44 Zubehör prod.group 44 addons













Artikelgruppe 44 Zubehör
 prod.group 44 addons

<p>044.1 Artikelnr./ partno.800064</p> <p>Blasleistenmodul 100mm PS16C, komplett</p> <p>Blasting strip module 100mm PS16C, complete</p>		
<p>044.2 Artikelnr./ partno.800083</p> <p>Blasleistenmodul 50mm PS16C, komplett</p> <p>Blasting strip module 50mm PS16C, complete</p>		
<p>044.3 Artikelnr./ partno.800089</p> <p>Blasleistenschliessleiste R (kompakt) PS16C, komplett</p> <p>Cover for compact blasting strip R PS16C, complete, with o-rings</p>		
<p>044.4 Artikelnr./ partno.800090</p> <p>Blasleistenschliessleiste L (kompakt) PS16C, komplett</p> <p>Cover for compact blasting strip L PS16C, complete, without o-rings</p>		
<p>044.5 Artikelnr./ partno.800094</p> <p>Blasleistenkreuzung PS16C, komplett</p> <p>Blasting strip junction PS16C, complete</p>		







Artikelgruppe 44 Zubehör
 prod.group 44 addons

044.6 Artikelnr./ partno.800124		
Blasleistenwinkel 1 PS16C, komplett Angle 1 for blast strip 45		
044.7 Artikelnr./ partno.800126		
Blasleistenwinkel 2 PS16C, komplett angle 2 for blasting strip 45		
044.8 Artikelnr./ partno.800128		
Blasleistenwinkel 3 PS16C, komplett Angle 3 for blast strip 45		
044.9 Artikelnr./ partno.800130		
Blasleistenwinkel 4 PS16C, komplett Angle 4 for blast strip 45		
044.10 Artikelnr./ partno.800153		
Blasleistendistanzmodul 100mm PS16C, komplett Blasting strip spacer module 100mm PS16C, complete		

Artikelgruppe 44 Zubehör
 prod.group 44 addons

<p>044.11 Artikelnr./ partno.800155</p>		
<p>Blasleistendistanzmodul 50mm PS16C, komplett Blasting strip spacer module 50mm PS16C, complete</p>		
<p>044.12 Artikelnr./ partno.800302</p>		
<p>Blasleistenwinkelstück 45°LHA PS16C, komplett, links hinten außenblasend Blasting strip angled piece 45°LHA PS16C, complete, spraying left, rear, outside</p>		
<p>044.13 Artikelnr./ partno.800304</p>		
<p>Blasleistenwinkelstück 45°LVI PS16C, komplett, links vorne innenblasend Blasting strip angled piece 45°LVI PS16C, complete, spraying left, front, inside</p>		
<p>044.14 Artikelnr./ partno.800306</p>		
<p>Blasleistenwinkelstück 45°RHA PS16C, komplett, rechts hinten außenblasend Blasting strip angled piece 45°RHA PS16C, complete, spraying right, rear, outside</p>		
<p>044.15 Artikelnr./ partno.800308</p>		
<p>Blasleistenwinkelstück 45°RVI PS16C, komplett, rechts vorne innenblasend Blasting strip angled piece 45°RVI PS16C, complete, spraying right, front, inside</p>		







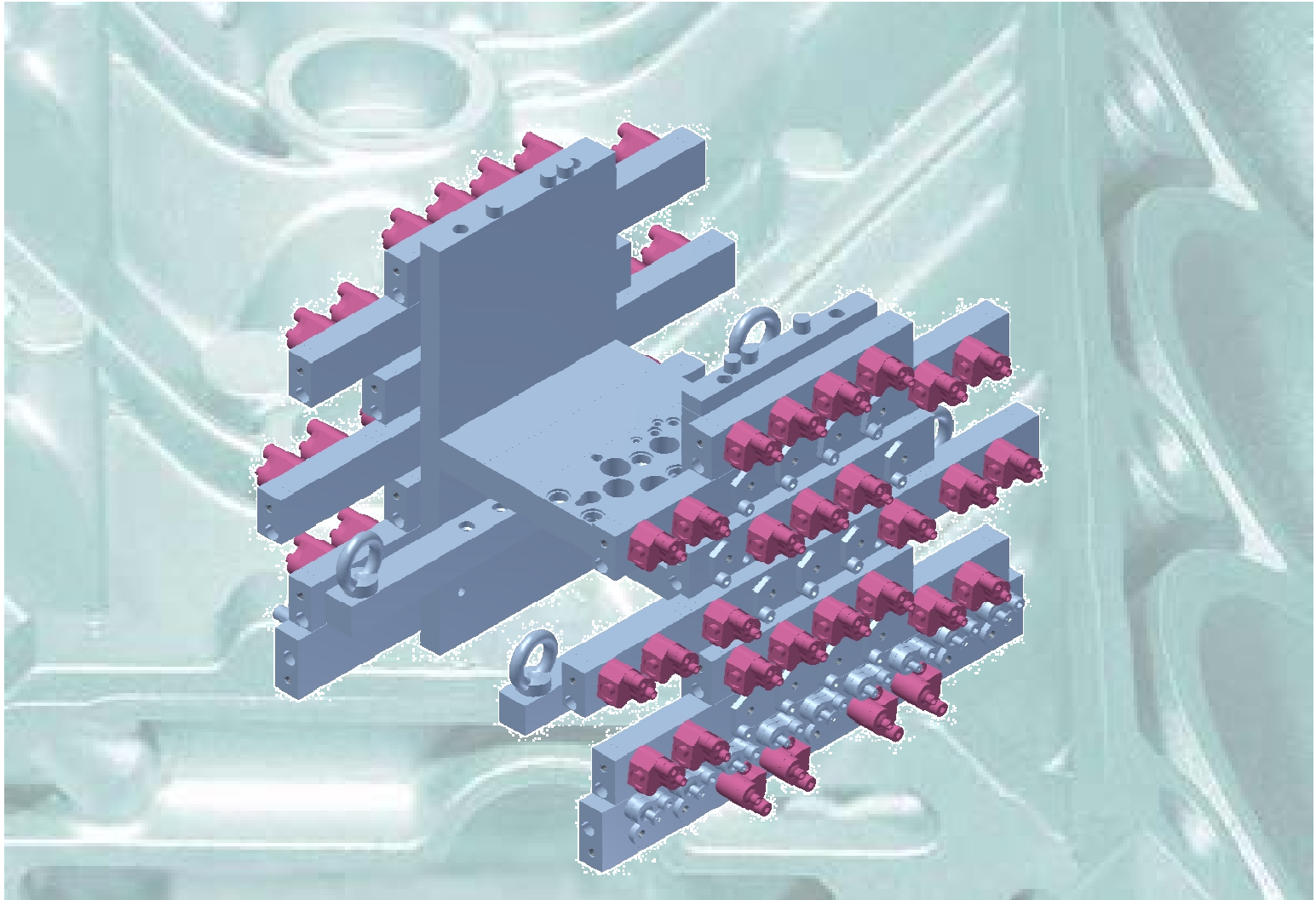



Artikelgruppe 44 Zubehör
prod.group 44 addons

044.16 Artikelnr./ partno.800356		
Blasteistendistanzmodul 10mm PS16C, komplett Blasting strip spacer module 10mm PS16C, complete		
044.17 Artikelnr./ partno.800379		
Blasteisten-Inversmodul o.O-R PS16C, komplett Blasting strip inverse module PS16C, complete, without o-rings		
044.18 Artikelnr./ partno.800381		
Blasteisten-Inversmodul m.O-R PS16C, komplett Blasting strip inverse module PS16C, complete, with o-rings		











Artikelgruppe 50 Zubehör prod.group 50 addons



Artikelgruppe 50 Zubehör
 prod.group 50 addons

050.1 Artikelnr./ partno.800008		
Sprühdüse SD14 SD-A-04+KD-A-06 Spray nozzle SD14 SD-A-04+KD-A-06		
050.2 Artikelnr./ partno.800278		
Sprühdüse SD14 Basis SD-A-04 Spray nozzle SD14 carrier SD-A-04		
050.3 Artikelnr./ partno.800542		
Sprühdüse SD14 SD-A-04+KD-A-02 Spray nozzle SD-A-04+KD-A-02		
050.4 Artikelnr./ partno.800543		
Sprühdüse SD14 SD-A-04+KD-A-04 Spray nozzle SD-A-04+KD-A-04		
050.5 Artikelnr./ partno.800544		
Sprühdüse SD14 SD-A-04+KD-A-08 Spray nozzle SD-A-04+KD-A-08		



Artikelgruppe 50 Zubehör
 prod.group 50 addons

050.6 Artikelnr./ partno.800545		
Sprühdüse SD14 SD-A-04+KD-A-10 Spray nozzle SD-A-04+KD-A-10		
050.7 Artikelnr./ partno.800546		
Sprühdüse SD14 SD-A-04+KD-A-15 Spray nozzle SD-A-04+KD-A-15		
050.8 Artikelnr./ partno.800547		
Sprühdüse SD14 SD-A-04+KD-A-20 Spray nozzle SD-A-04+KD-A-20		
050.9 Artikelnr./ partno.800548		
Sprühdüse SD14 SD-A-04+KD-A-F Spray nozzle SD-A-04+KD-A-F		
050.10 Artikelnr./ partno.800549		
Sprühdüse SD14 SD-A-04+KD-A-B Spray nozzle SD-A-04+KD-A-B		

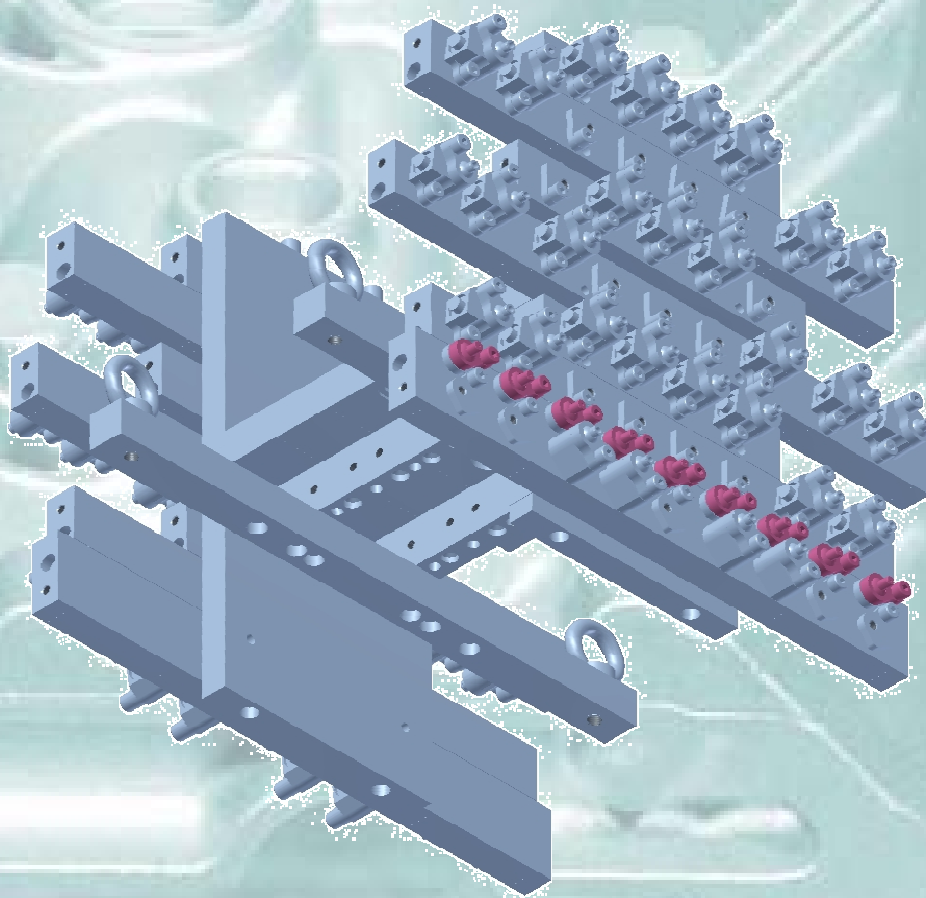
Artikelgruppe 70 Zubehör prod.group 70 addons



Artikelgruppe 70 Zubehör
 prod.group 70 addons

070.1 Artikelnr./ partno.323445		
Blas-Set mit KD-I-30 (100mm lang) ohne Einsatz, mit Schraube M8, gerundet Blasting set with KD-I-30 (100mm) without insert, with screw M8, rounded		
070.2 Artikelnr./ partno.800133		
Blas-Set mit KD-I-26 ohne Einsatz, mit Schraube M8, gerundet Blasting set with KD-I-26 without insert, with screw M8, rounded		
070.3 Artikelnr./ partno.801254		
Blas-Set mit KD-I-30 ohne Einsatz, mit Schraube M8, gerundet Blasting set with KD-I-30 without insert, with screw M8, rounded		
070.4 Artikelnr./ partno.801328		
Blas-Set mit KD-I-26 (50mm lang) ohne Einsatz, mit Schraube M8, gerundet Blasting set with KD-I-26 (50mm) without insert, with screw M8, rounded		
070.5 Artikelnr./ partno.801382		
Blas-Set mit KD-I-20 ohne Einsatz, mit Schraube M8, gerundet Blasting set with KD-I-20 without insert, with screw M8, rounded		



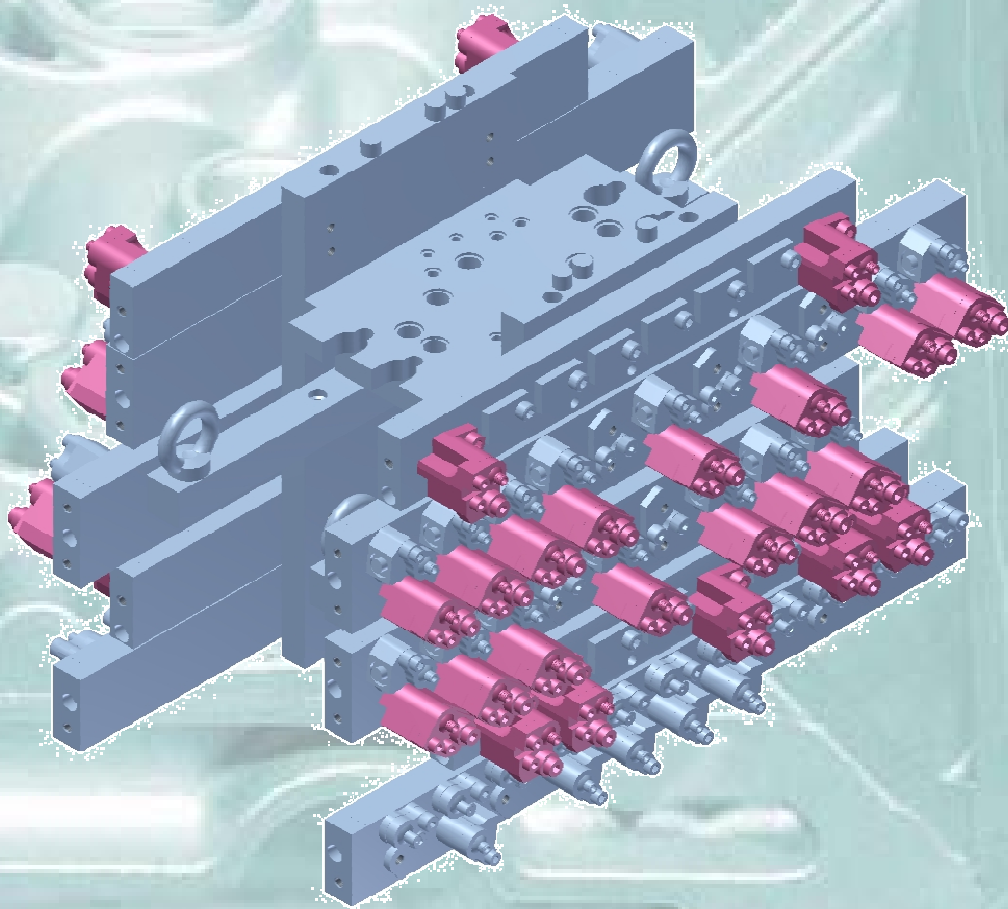







Artikelgruppe 80 Zubehör prod.group 80 addons













Artikelgruppe 80 Zubehör
prod.group 80 addons

<p>080.1 Artikelnr./ partno.800413</p> <p>Dosierdüse DD-A-4-76-V+KD-A-06</p> <p>Dosing nozzle DD-A-4-76-V+KD-A-06</p>		
<p>080.2 Artikelnr./ partno.800593</p> <p>Dosierdüse Basis DD-A-4-76-V</p> <p>dosing nozzle carrier DD-A-4-76-V</p>		
<p>080.3 Artikelnr./ partno.800807</p> <p>Dosierdüse DD-A-3-43-V+KD-A-06</p> <p>Dosing nozzle DD-A-3-43-V+KD-A-06</p>		
<p>080.4 Artikelnr./ partno.801120</p> <p>Dosierdüse Basis DD-A-3-43-V</p> <p>dosing nozzle carrier DD-A-3-43-V</p>		
<p>080.5 Artikelnr./ partno.801130</p> <p>Dosierdüse DD-A-5-119-V+KD-A-06</p> <p>Dosing nozzle DD-A-5-119-V+KD-A-06</p>		











Artikelgruppe 80 Zubehör
 prod.group 80 addons

080.6 Artikelnr./ partno.801149		
Dosierdüse Basis DD-A-5-119-V dosing nozzle carrier DD-A-5-119-V		
080.7 Artikelnr./ partno.801285		
Dosierdüse DDV-A-4-76-V+KD-A-06 Dosing nozzle DDV-A-4-76-V+KD-A-06		
080.8 Artikelnr./ partno.801329		
Dosierdüse DDV-A-3-43-V+KD-A-06 Dosing nozzle DDV-A-3-43-V+KD-A-06		
080.9 Artikelnr./ partno.801333		
Dosierdüse Basis DDV-A-4-76-V Dosing nozzle carrier DDV-A-4-76-V		
080.10 Artikelnr./ partno.801337		
Dosierdüse DDV-A-2-19-V+KD-A-06 Dosing nozzle DDV-A-2-19-V+KD-A-06		







Artikelgruppe 80 Zubehör
prod.group 80 addons

080.11 Artikelnr./ partno.801338		
Dosierdüse DDV-A-5-119-V+KD-A-06 Dosing nozzle DDV-A-5-119-V+KD-A-06		
080.12 Artikelnr./ partno.801511		
Dosierdüse Basis DDV-A-3-43-V Dosing nozzle carrier DDV-A-3-43-V		
080.13 Artikelnr./ partno.801588		
Kappe mit Festanschlag 1 für Dosierdüse, komplett Cap with fixed stop 1 for dosing nozzle, complete		
080.14 Artikelnr./ partno.801589		
Kappe mit Festanschlag 2 für Dosierdüse, komplett Cap with fixed stop 2 for dosing nozzle, complete		
080.15 Artikelnr./ partno.801590		
Kappe mit Festanschlag 3 für Dosierdüse, komplett Cap with fixed stop 3 for dosing nozzle, complete		

Artikelgruppe 80 Zubehör
 prod.group 80 addons

080.16 Artikelnr./ partno.801591		
Kappe mit Festanschlag 4 für Dosierdüse, komplett Cap with fixed stop 4 for dosing nozzle, complete		
080.17 Artikelnr./ partno.801592		
Kappe mit Festanschlag 5 für Dosierdüse, komplett Cap with fixed stop 5 for dosing nozzle, complete		
080.18 Artikelnr./ partno.801593		
Kappe mit Festanschlag 6 für Dosierdüse, komplett Cap with fixed stop 6 for dosing nozzle, complete		
080.19 Artikelnr./ partno.801622		
Dosierdüse Basis DDV-A-5-119-V Dosing nozzle carrier DDV-A-5-119-V		
080.20 Artikelnr./ partno.801681		
Sprühdüse FSD FSD-A-10+KD-A-06 Spray nozzle FSD FSD-A-10+KD-A-06		







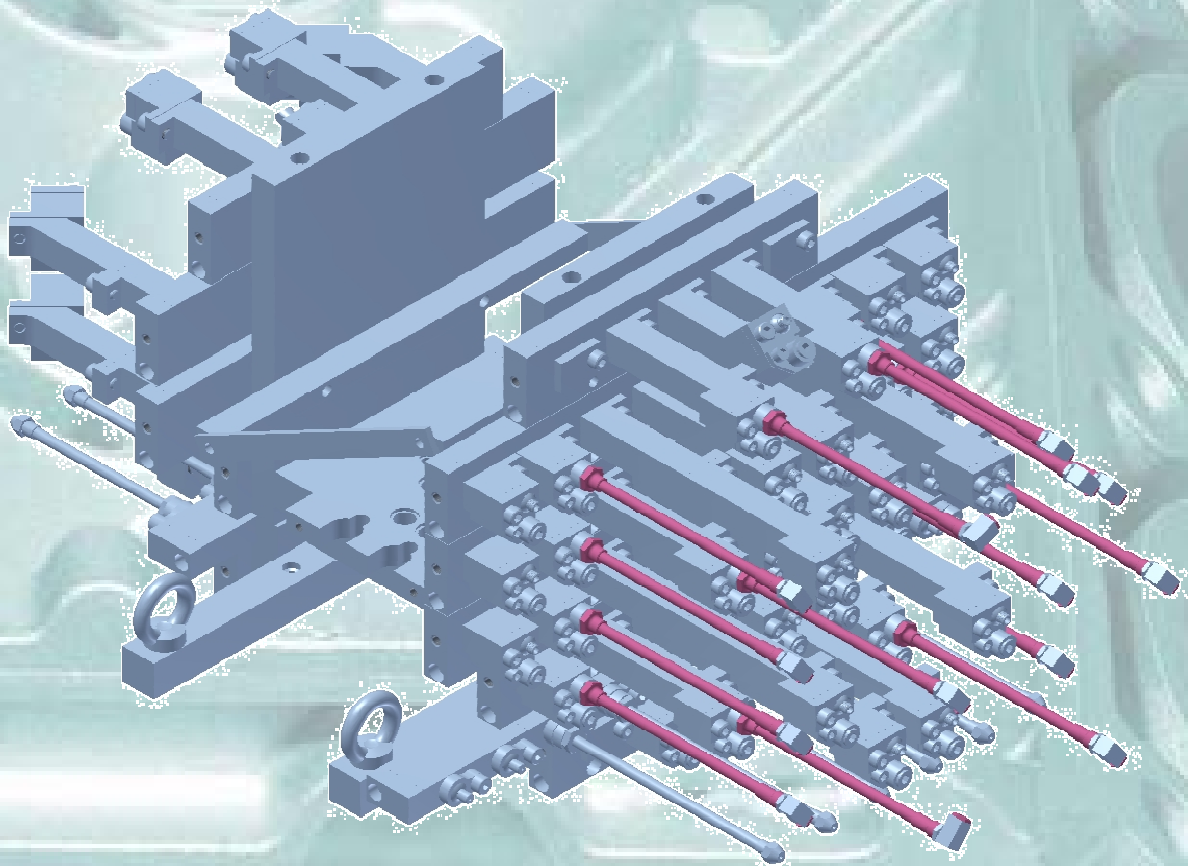



Artikelgruppe 80 Zubehör
prod.group 80 addons

080.21 Artikelnr./ partno.801690		
Sprühdüse FSD FSD-A-10+KD-A-04 Spray nozzle FSD FSD-A-10+KD-A-04		
080.22 Artikelnr./ partno.801691		
Sprühdüse FSD Basis FSD-A-10 Spray nozzle FSD basis FSD-A-10		
080.23 Artikelnr./ partno.801782		
Sprühdüse FSD FSD-A-10+KD-A-F-03-FZ Spray nozzle FSD FSD-A-09+KD-A-F-03-FZ		











Artikelgruppe 90 Zubehör prod.group 90 addons



Artikelgruppe 90 Zubehör
prod.group 90 addons

090.1 Artikelnr./ partno.177733		
Rohr R-A-100 Tube R-A-100		
090.2 Artikelnr./ partno.177741		
Rohr R-A-150 Tube R-A-150		
090.3 Artikelnr./ partno.177758		
Rohr R-A-200 Tube R-A-200		
090.4 Artikelnr./ partno.177766		
Rohr R-A-250 Tube R-A-250		
090.5 Artikelnr./ partno.177774		
Rohr R-A-300 Tube R-A-300		







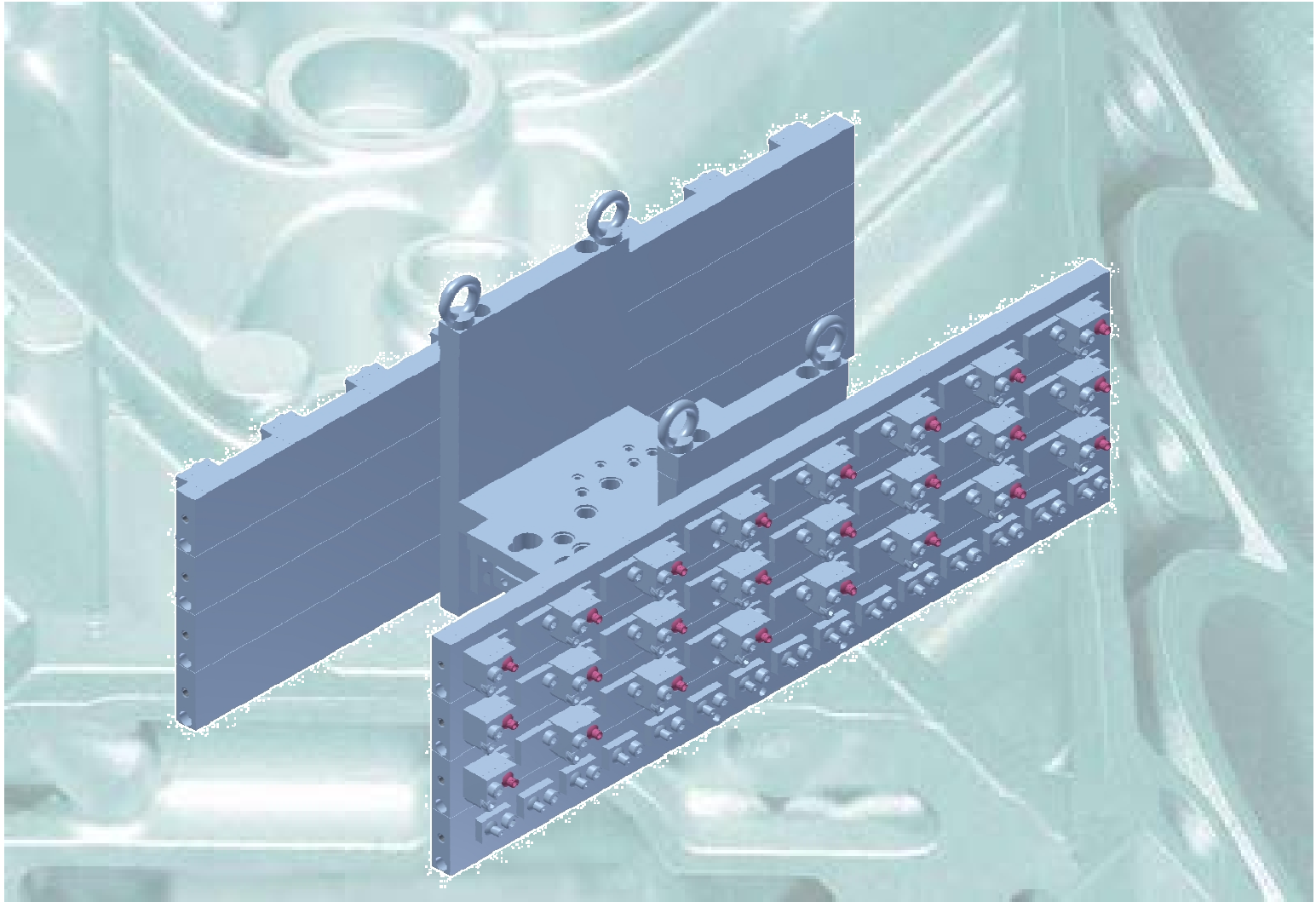



Artikelgruppe 90 Zubehör
 prod.group 90 addons

090.6 Artikelnr./ partno.179077		
Rohrenddüse RD-A-10 Nozzle for tube RD-A-10		
090.7 Artikelnr./ partno.306598		
Verschluss für Sprühhrohr AM RD-A-V blind plug RD-A-V		
090.8 Artikelnr./ partno.800282		
Umlenkung 90° für Rohrenddüse RD-A, komplett Direction change 90° for nozzle for tube RD-A, complete		
090.9 Artikelnr./ partno.801055		
T-Umlenkung für Rohrenddüse RD-A, komplett T-direction change for nozzle for tube RD-A; complete		
090.10 Artikelnr./ partno.801058		
L-Umlenkung für Rohrenddüse RD-A, komplett L-direction change for nozzle for tube RD-A; complete		











Artikelgruppe 91 Zubehör prod.group 91 addons



Artikelgruppe 91 Zubehör
 prod.group 91 addons

091.1 Artikelnr./ partno.177709		
Kugeldüse KD-A-06 Ball nozzle KD-A-06		
091.2 Artikelnr./ partno.177717		
Kugeldüse KD-A-B-60° / Mittel 1xø0,4 / 6xø0,6 Ball nozzle KD-A-B-60° / fluid 1xø0,4 / 6xø0,6		
091.3 Artikelnr./ partno.177725		
Kugeldüse KD-A-F Ball nozzle KD-A-F		
091.4 Artikelnr./ partno.177824		
Kugeldüse KD-A-08 Ball nozzle KD-A-08		
091.5 Artikelnr./ partno.177832		
Kugeldüse KD-A-10 Ball nozzle KD-A-10		







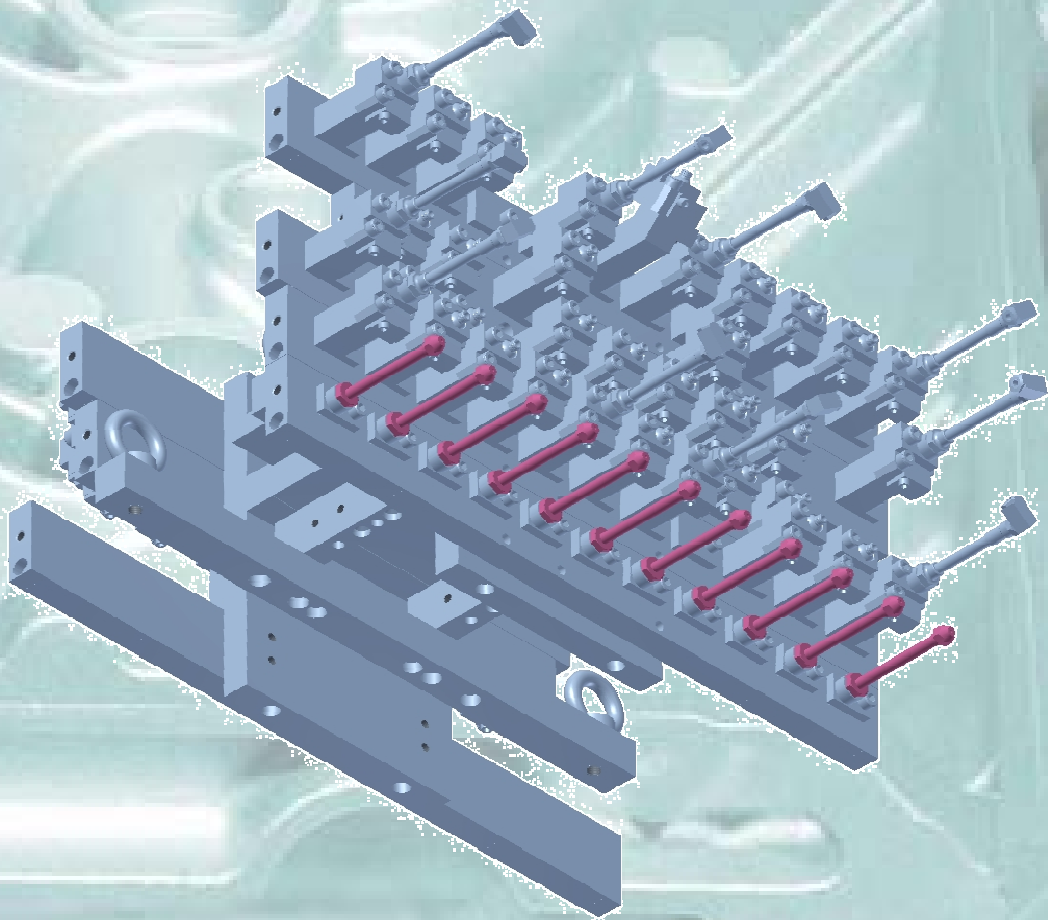

Artikelgruppe 91 Zubehör
 prod.group 91 addons

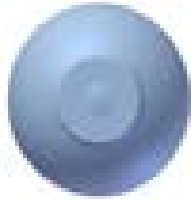
091.6 Artikelnr./ partno.302383		
Kugeldüse KD-A-06-S (Verstellbereich 120°) Ball nozzle KD-A-06-S (adjusting range 120°)		
091.7 Artikelnr./ partno.304146		
Kugeldüse KD-A-15 Ball nozzle KD-A-15		
091.8 Artikelnr./ partno.304147		
Kugeldüse KD-A-20 Ball nozzle KD-A-20		
091.9 Artikelnr./ partno.800400		
Kugeldüse KD-A-02 Ball nozzle KD-A-02		
091.10 Artikelnr./ partno.800635		
Kugeldüse KD-A-06-S (Verstellbereich 180°) Ball nozzle KD-A-06-S (adjusting range 180°)		







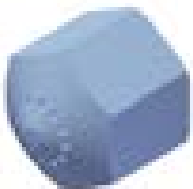

Artikelgruppe 92 Zubehör prod.group 92 addons













Artikelgruppe 92 Zubehör
 prod.group 92 addons

092.1 Artikelnr./ partno.129643		
Kugeldüse KD-I-26 Ball nozzle KD-I-26		
092.2 Artikelnr./ partno.129650		
Rohr R-IB-150 Tube R-IB-150		
092.3 Artikelnr./ partno.137273		
Rohr R-IB-100 Tube R-IB-100		
092.4 Artikelnr./ partno.137695		
Rohrenddüse RD-I-F Nozzle for tube RD-I-F		
092.5 Artikelnr./ partno.137703		
Rohrenddüse RD-I-B Nozzle for tube RD-I-B		











Artikelgruppe 92 Zubehör
 prod.group 92 addons

092.6 Artikelnr./ partno.138701		
Rohr R-IB-200 Tube R-IB-200		
092.7 Artikelnr./ partno.138719		
Rohr R-IB-250 Tube R-IB-250		
092.8 Artikelnr./ partno.138727		
Rohr R-IB-300 Tube R-IB-300		
092.9 Artikelnr./ partno.143768		
Kugeldüse KD-I-F Ball nozzle KD-I-F		
092.10 Artikelnr./ partno.144097		
Rohrenddüse RD-I-26 Nozzle for tube RD-I-26		











Artikelgruppe 92 Zubehör
prod.group 92 addons

092.11 Artikelnr./ partno.144105		
Rohr R-IB-60 Tube R-IB-60		
092.12 Artikelnr./ partno.144113		
Kugeldüse KD-I-26-S (Verstellb. 120°) Ball nozzle KD-I-26-S (range 120°)		
092.13 Artikelnr./ partno.144121		
Kugeldüse KD-I-26-S (Verstellb. 180°) Ball nozzle KD-I-26-S (range 180°)		
092.14 Artikelnr./ partno.144139		
Kugeldüse KD-I-B Ball nozzle KD-I-B		
092.15 Artikelnr./ partno.305887		
Rohr R-IB-60 ohne Düsengewinde Tube R-IB-60 without thread		











Artikelgruppe 92 Zubehör
prod.group 92 addons

092.16 Artikelnr./ partno.305888		
Rohr R-IB-100 ohne Düsengewinde Tube R-IB-100 without threat		
092.17 Artikelnr./ partno.305889		
Rohr R-IB-150 ohne Düsengewinde Tube R-IB-150 without threat		
092.18 Artikelnr./ partno.305890		
Rohr R-IB-200 ohne Düsengewinde Tube R-IB-200 without threat		
092.19 Artikelnr./ partno.305891		
Rohr R-IB-250 ohne Düsengewinde Tube R-IB-250 without threat		
092.20 Artikelnr./ partno.305892		
Rohr R-IB-300 ohne Düsengewinde Tube R-IB-300 without threat		

Artikelgruppe 92 Zubehör
 prod.group 92 addons

092.21 Artikelnr./ partno.800383		
Umlenkung 90° für Rohrenddüse RD-I, komplett Direction change 90° for nozzle for tube RD-I, complete		
092.22 Artikelnr./ partno.801078		
Kugeldüse KD-I-10 Ball nozzle KD-I-10		
092.23 Artikelnr./ partno.801079		
Kugeldüse KD-I-15 Ball nozzle KD-I-15		
092.24 Artikelnr./ partno.801255		
Kugeldüse KD-I-30 Ball nozzle KD-I-30		
092.25 Artikelnr./ partno.801374		
Kugeldüse KD-I-20 Ball nozzle KD-I-20		







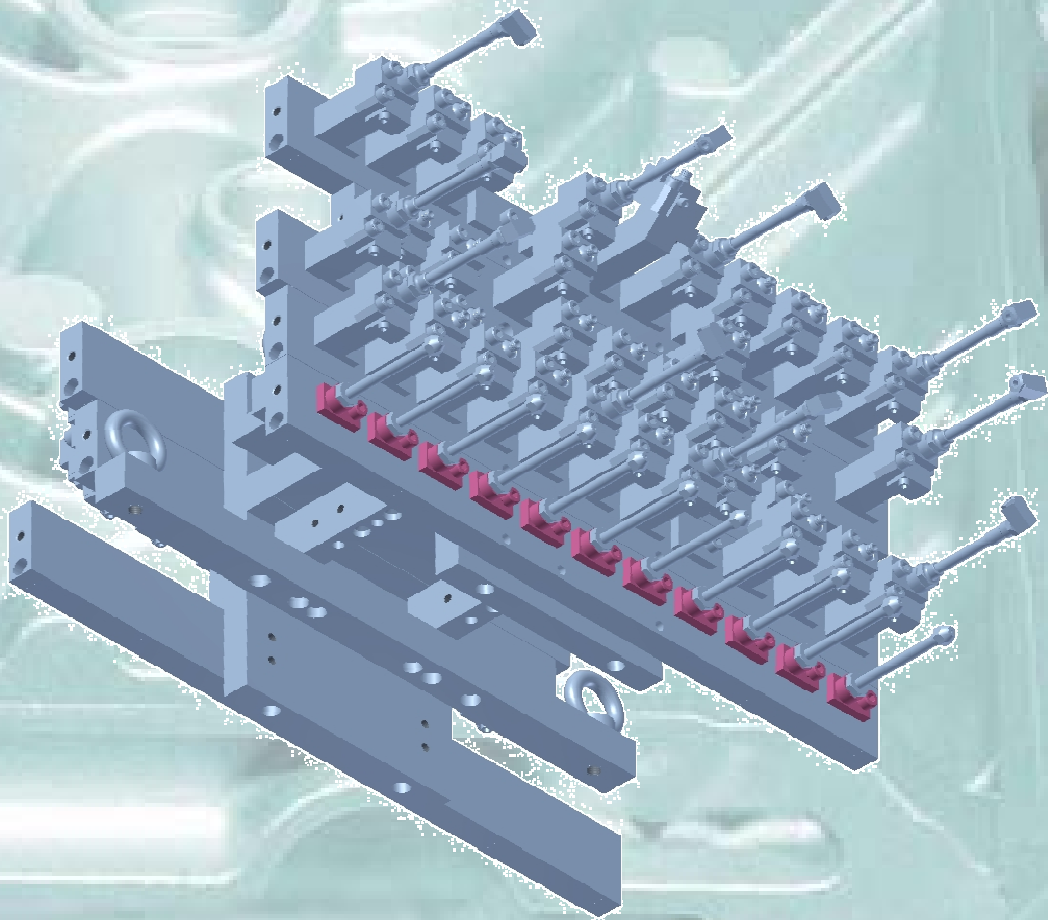

Artikelgruppe 92 Zubehör
 prod.group 92 addons

092.26 Artikelnr./ partno.801407		
Rohrenddüse RD-I-B / 6 x Ø1,5mm Nozzle for tube RD-I-B / 6xØ1,5mm		
092.27 Artikelnr./ partno.801491		
Rohrenddüse RD-I-30 Nozzle for tube RD-I-30		
092.28 Artikelnr./ partno.801493		
Rohrenddüse RD-I-35 Nozzle for tube RD-I-35		
092.29 Artikelnr./ partno.801495		
Rohrenddüse RD-I-40 Nozzle for tube RD-I-40		
092.30 Artikelnr./ partno.801503		
Rohrenddüse RD-I-20 Nozzle for tube RD-I-20		

Artikelgruppe 93 Zubehör prod.group 93 addons









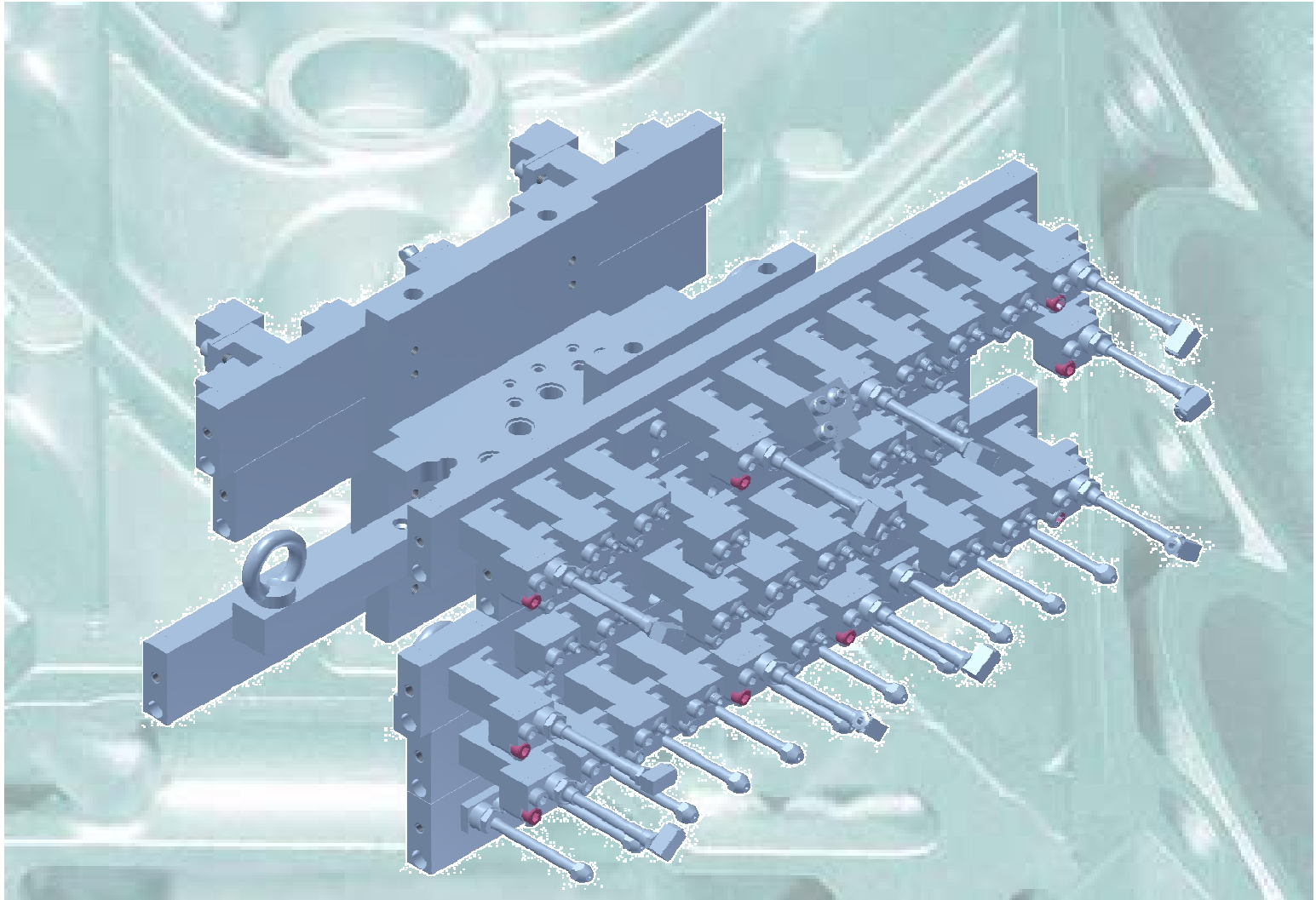



Artikelgruppe 93 Zubehör
 prod.group 93 addons

093.1 Artikelnr./ partno.179564		
Halteplatte für Rohr auf Blasteiste mit Schraube M8, rechteckig, komplett Holding plate for tube on a blasting strip		
093.2 Artikelnr./ partno.800132		
Verschuß (Blindplatte Blasdüse) mit Schraube M8 und O-Ring, gerundet, komplett Cover for blasting exit with screw M8 and O-ring, rounded, complete		
093.3 Artikelnr./ partno.800774		
Blasdüsenerhöhung 50mm PS16C, komplett Blasting nozzle extension 50mm PS16C, complete		
093.4 Artikelnr./ partno.801342		
Blasdüsenerhöhung 100mm PS16C, komplett Blasting nozzle extension 100mm PS16C, complete		











Artikelgruppe 94 Zubehör prod.group 94 addons





Artikelgruppe 94 Zubehör
 prod.group 94 addons

094.1 Artikelnr./ partno.135913		
Dosierblende DB-1-06 Dosing insert DB-1-06		
094.2 Artikelnr./ partno.135939		
Dosierblende DB-0-04 Dosing insert DB-0-04		
094.3 Artikelnr./ partno.135954		
Dosierblende DB-2-08 Dosing insert DB-2-08		
094.4 Artikelnr./ partno.135970		
Dosierblende DB-3-10 Dosing insert DB-3-10		
094.5 Artikelnr./ partno.135996		
Dosierblende DB-4-12 Dosing insert DB-4-12		

Artikelgruppe 94 Zubehör
 prod.group 94 addons

094.6 Artikelnr./ partno.136150		
Dosierblende DB-6-20 Dosing insert DB-6-20		
094.7 Artikelnr./ partno.138073		
Dosierblende DB-5-16 Dosing insert DB-5-16		
094.8 Artikelnr./ partno.194142		
Dosierblende DB-E Dosing insert DB-E		
094.9 Artikelnr./ partno.800079		
Verschuß (Blindplatte Sprühdüse) mit Schraube M8 und O-Ring, gerundet, komplett Cover plate with screw M8 and O-ring, rounded, complete		
094.10 Artikelnr./ partno.801403		
Dosierblende DB-0-01 Dosing insert DB-0-01		



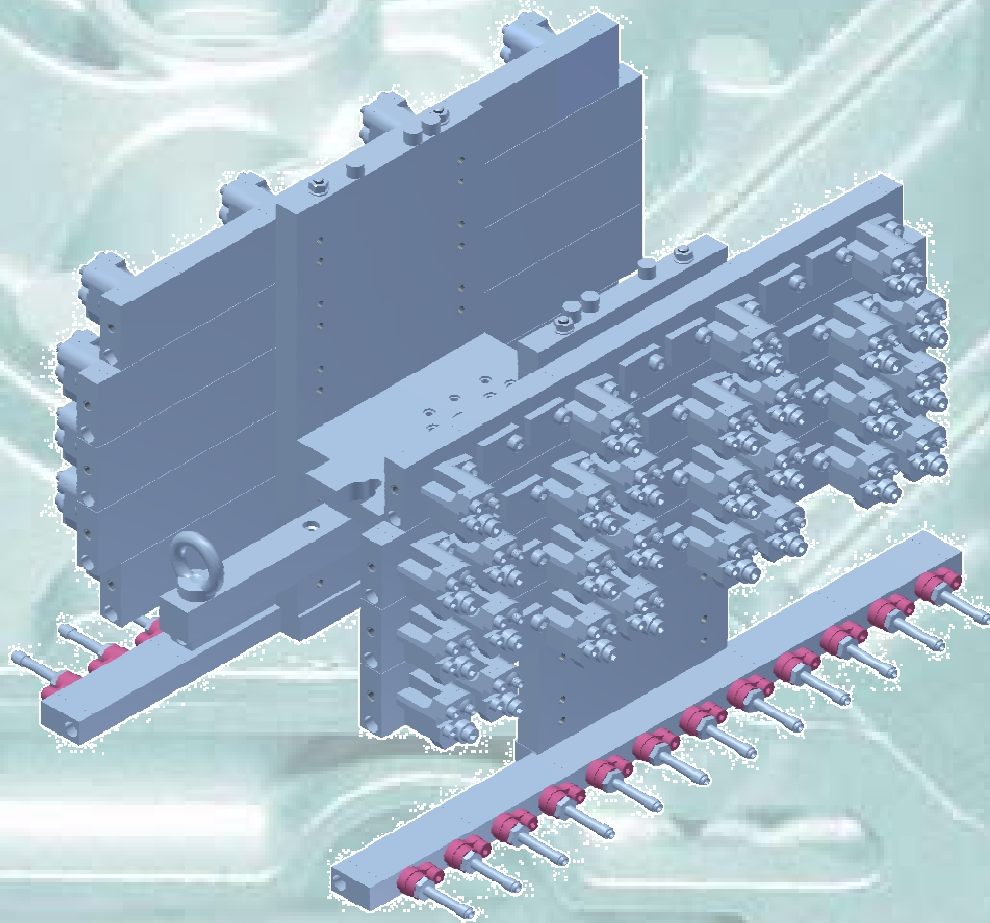

Artikelgruppe 094 Zubehör
prod.group 094 addons

094.11 Artikelnr./ partno.801405		
Dosierblende DB-0-02 Dosing insert DB-0-02		

Artikelgruppe 95 Zubehör prod.group 95 addons



Artikelgruppe 95 Zubehör
prod.group 95 addons

095.1 Artikelnr./ partno.800009		
Klemmdeckel für Kugeldüse mit Schraube M8, gerundet, komplett Clamp plate for ball nozzle with screw M8 and O-ring, rounded, complete		
095.2 Artikelnr./ partno.800135		
Halteplatte für Rohr mit Schraube M8, gerundet, komplett Holding plate for tube with screw M8 and O-ring, rounded, complete		

Artikelgruppe 96 Zubehör prod.group 96 addons

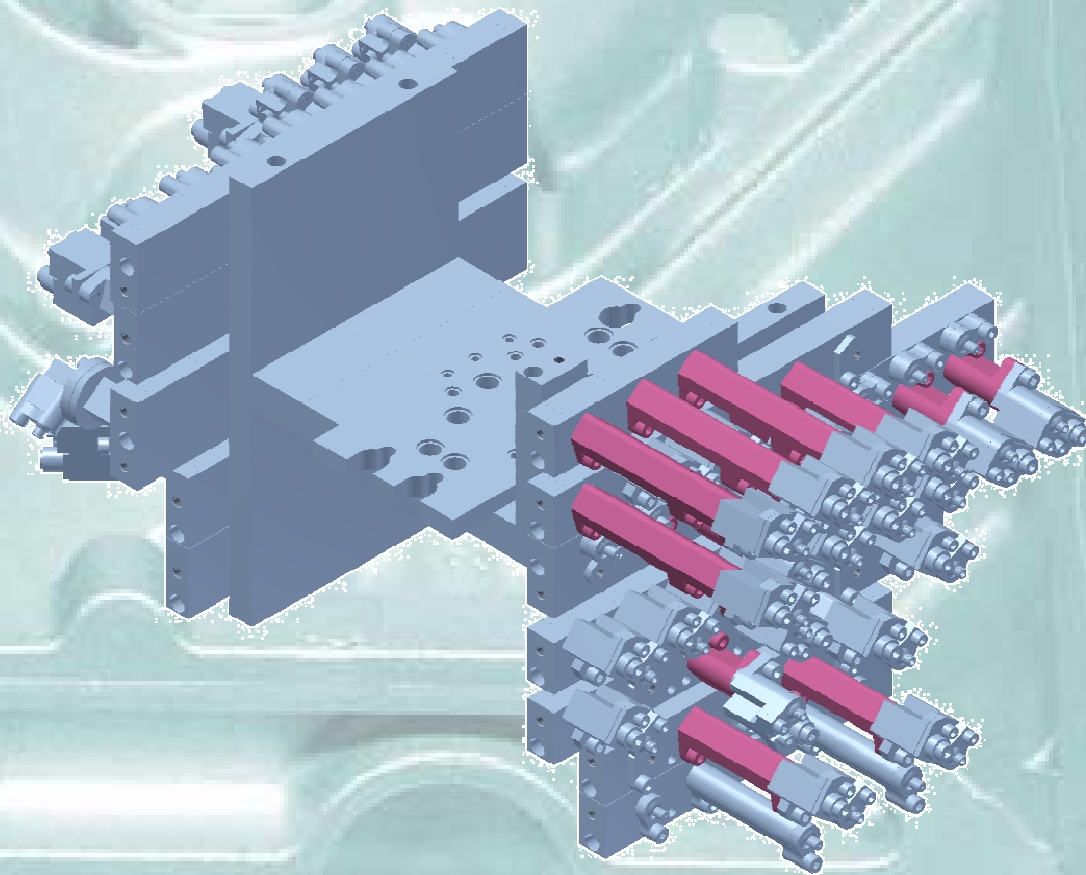



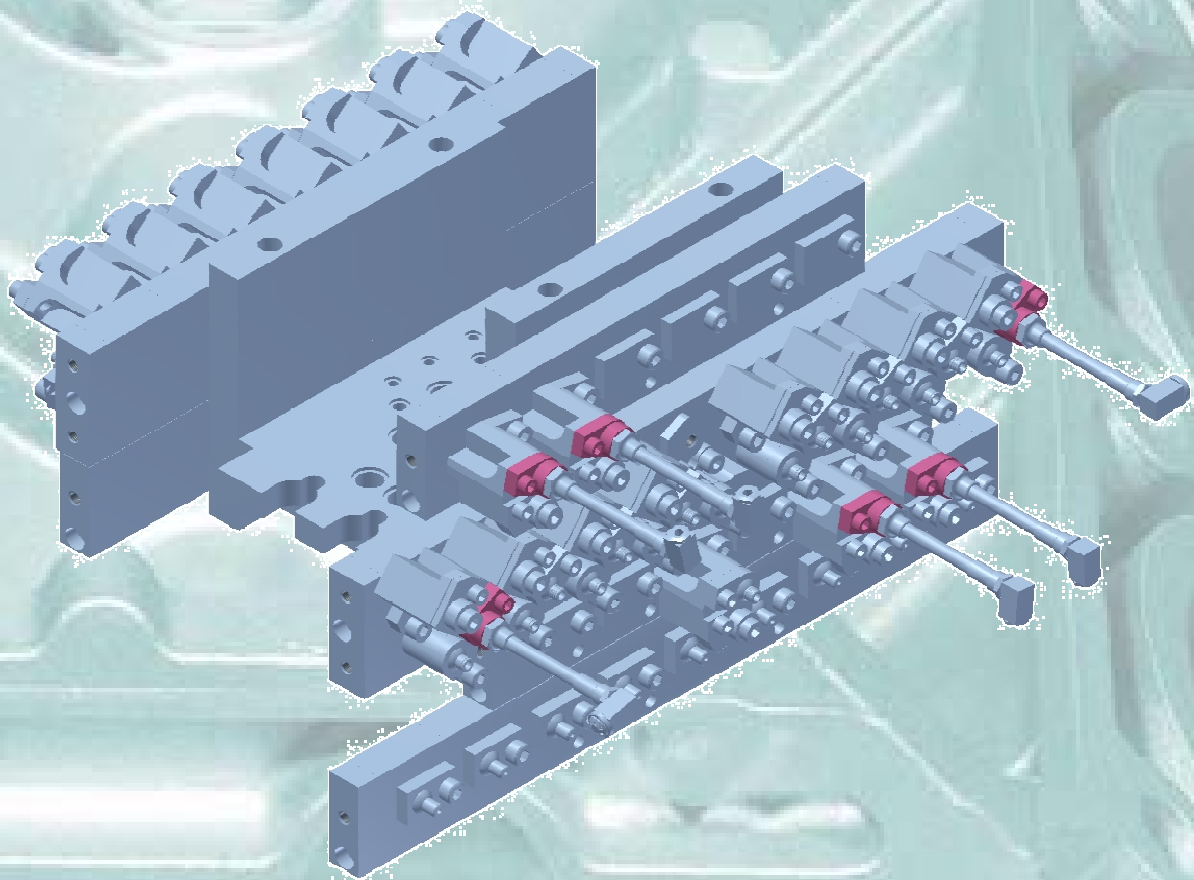

Artikelgruppe 96 Zubehör
 prod.group 96 addons

096.1 Artikelnr./ partno.800137		
Sprühdüsenerhöhung 50mm PS16C, komplett Spray nozzle extension 50mm PS16C, complete		
096.2 Artikelnr./ partno.800139		
Sprühdüsenerhöhung 100mm PS16C, komplett Spray nozzle extension 100mm PS16C, complete		
096.3 Artikelnr./ partno.800602		
Adapterplatte für Sprühdüse PS16C zu PS16, komplett Adaptor plate for spray nozzle PS16C to PS16, complete		

Artikelgruppe 97 Zubehör prod.group 97 addons









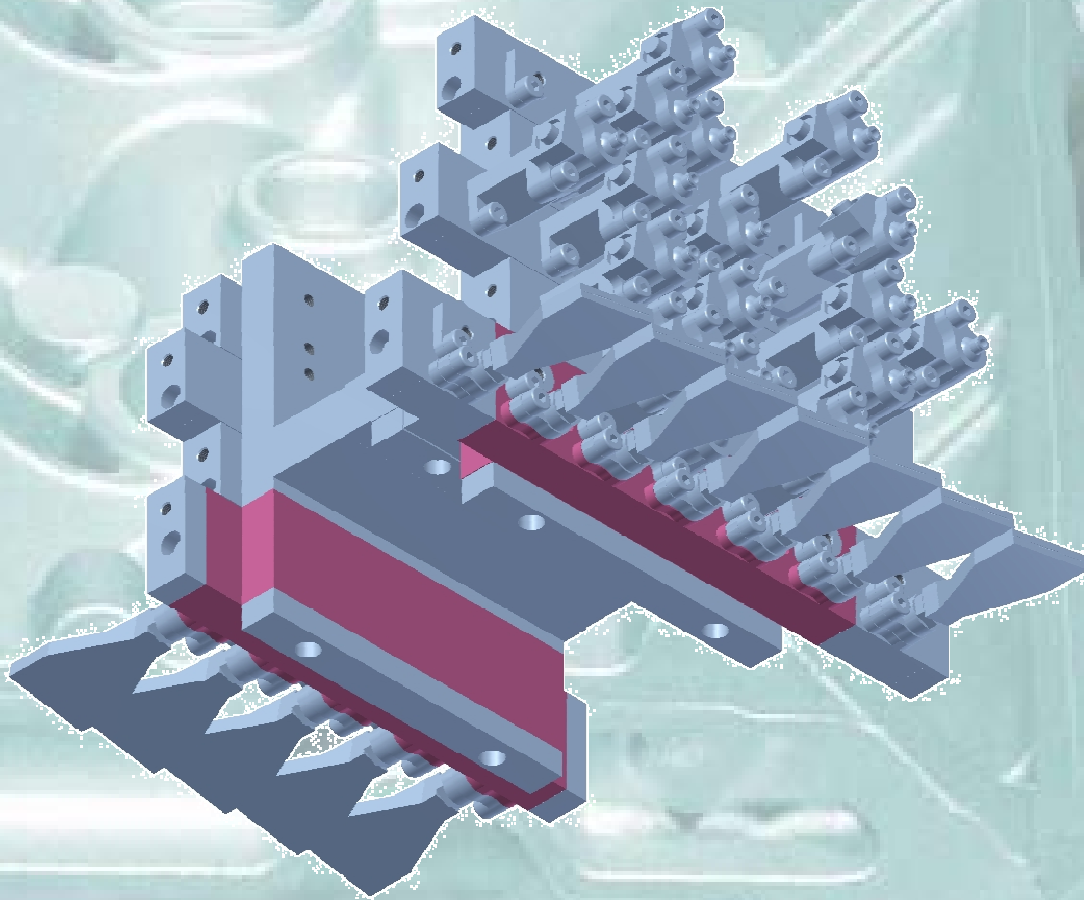



Artikelgruppe 97 Zubehör
prod.group 97 addons

097.1 Artikelnr./ partno.244822		
Halteplatte für Rohr mit Schraube M6, gerundet, komplett Holding plate for spraying tube (M6 screw)		
097.2 Artikelnr./ partno.244830		
Klemmdeckel für Kugeldüse mit Schraube M6, gerundet, komplett Clamp plate for ball nozzle with screw M6 and O-ring, rounded		





Artikelgruppe 100 Sonderteile prod.group 100 special parts



Artikelgruppe 100 Sonderteile
 prod.group 100 special parts

100.1 Artikelnr./ partno.800813		
Adaptermodul 50mm PS16-6, komplett (mit Schräge) Adaptor module 50mm PS16-6, complete (with slant)		
100.2 Artikelnr./ partno.800939		
Verteilerschließplatte O PS16-6, komplett, ohne O-Ringe (mit Schräge) Endplate upside PS16-6, complete (en biais)		
100.3 Artikelnr./ partno.801049		
Adaptermodul 25mm PS16/PS16C-6, komplett (schräg) Adaptor module 25mm PS16/PS16C-6, complete		
100.4 Artikelnr./ partno.801227		
Kompaktsprühleiste 200mm Kreis 3/4-Kreis 5/6 PS16C-6, komplett Compact spray strip 200mm circuit 3/4-circuit 5/6 PS16C-6, complete		
100.5 Artikelnr./ partno.801303		
Kompaktsprühleiste 225mm Kreis 5/6 PS16C-6, komplett (sonder) Spray strip 225mm circuit 5/6		

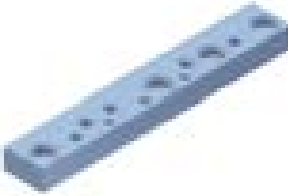





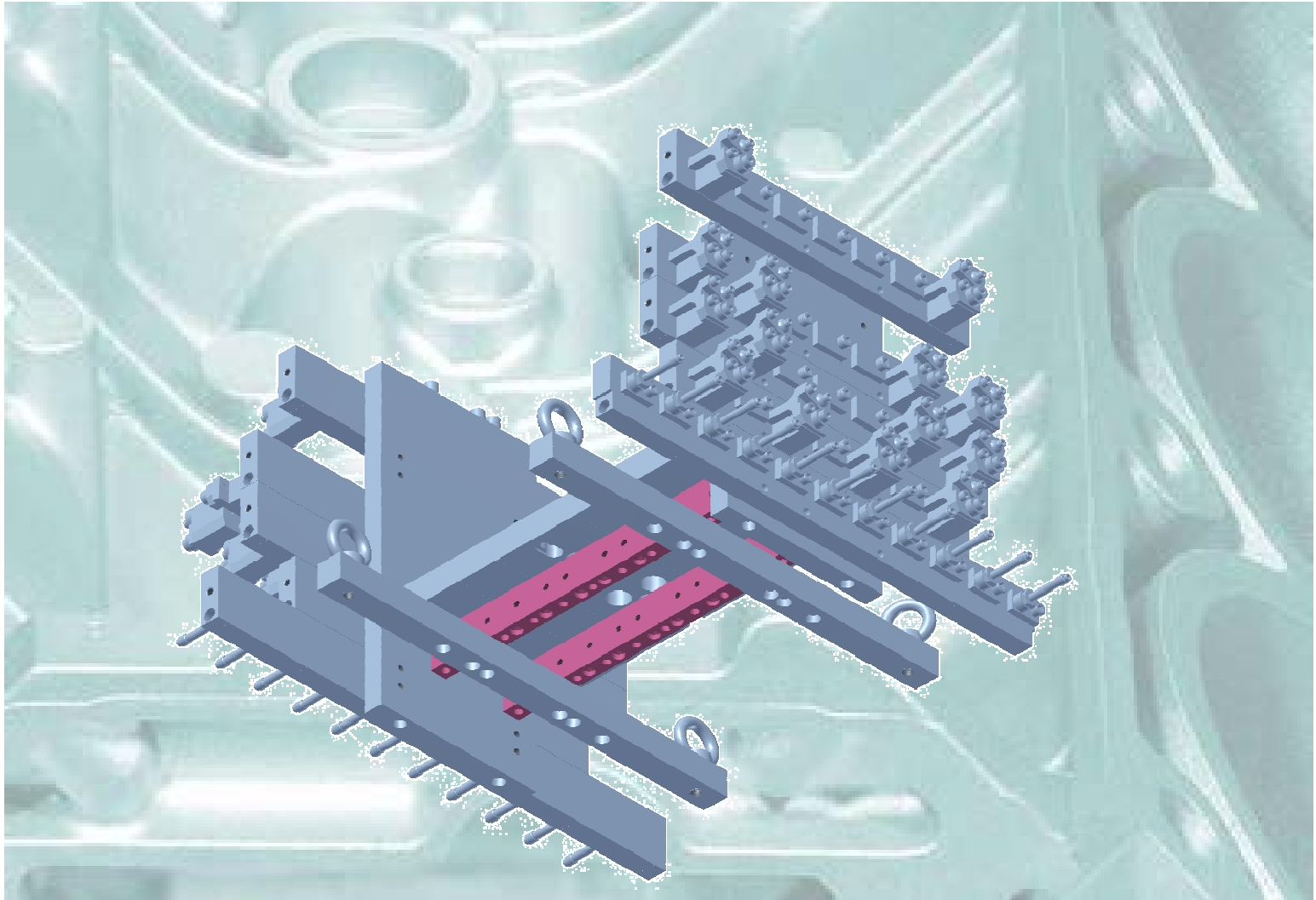



Artikelgruppe 100 Sonderteile
prod.group 100 special parts

100.6 Artikelnr./ partno.801305		
Kompaktsprühleistenmodul 45mm PS16C, komplett (sonder) Compact spray strip module 45mm PS16C, complete (special)		
100.7 Artikelnr./ partno.801385		
Verteilerschließplatte U PS16-6, komplett, mit Mittelanschluss Distributor cover below PS16-6, complete, without O-rings		











Artikelgruppe 110 Handling, Versteifung, etc. prod.group 110 handling / strengthening / etc



Artikelgruppe 110 Handling, Versteifung, etc.
 prod.group 110 handling / strengthening / etc

<p>110.1 Artikelnr./ partno.800656</p> <p>Verstärkungsleiste Länge : 300 mm</p> <p>Reinforcing strip length = 300 mm</p>		
<p>110.2 Artikelnr./ partno.800664</p> <p>Verstärkungsleiste Länge : 400 mm</p> <p>Reinforcing strip length = 400 mm</p>		
<p>110.3 Artikelnr./ partno.800665</p> <p>Verstärkungsleiste Länge : 500 mm</p> <p>Reinforcing strip length = 500 mm</p>		
<p>110.4 Artikelnr./ partno.800772</p> <p>Verstärkungsleiste Länge : 250 mm</p> <p>Reinforcing strip length = 250 mm</p>		
<p>110.5 Artikelnr./ partno.800850</p> <p>Verstärkungsleiste Länge : 260 mm /unsymetr.</p> <p>Reinforcing strip length = 260 mm</p>		

Artikelgruppe 110 Handling, Versteifung, etc.
 prod.group 110 handling / strengthening / etc

110.6 Artikelnr./ partno.800899		
Befestigungsleiste für Versteifung B=226mm attachment strip for reinforcing B= 226mm		
110.7 Artikelnr./ partno.800929		
Befestigungsleiste für Versteifung B=350mm attachment strip for reinforcing B= 350mm		
110.8 Artikelnr./ partno.800967		
Verstärkungsleiste Länge : 225 mm Reinforcing strip length = 225 mm		
110.9 Artikelnr./ partno.801061		
Befestigungsleiste für Versteifung B=300mm attachment strip for reinforcing B= 300mm		
110.10 Artikelnr./ partno.801144		
Verstärkungsleiste Länge : 600 mm Reinforcing strip length = 600 mm		







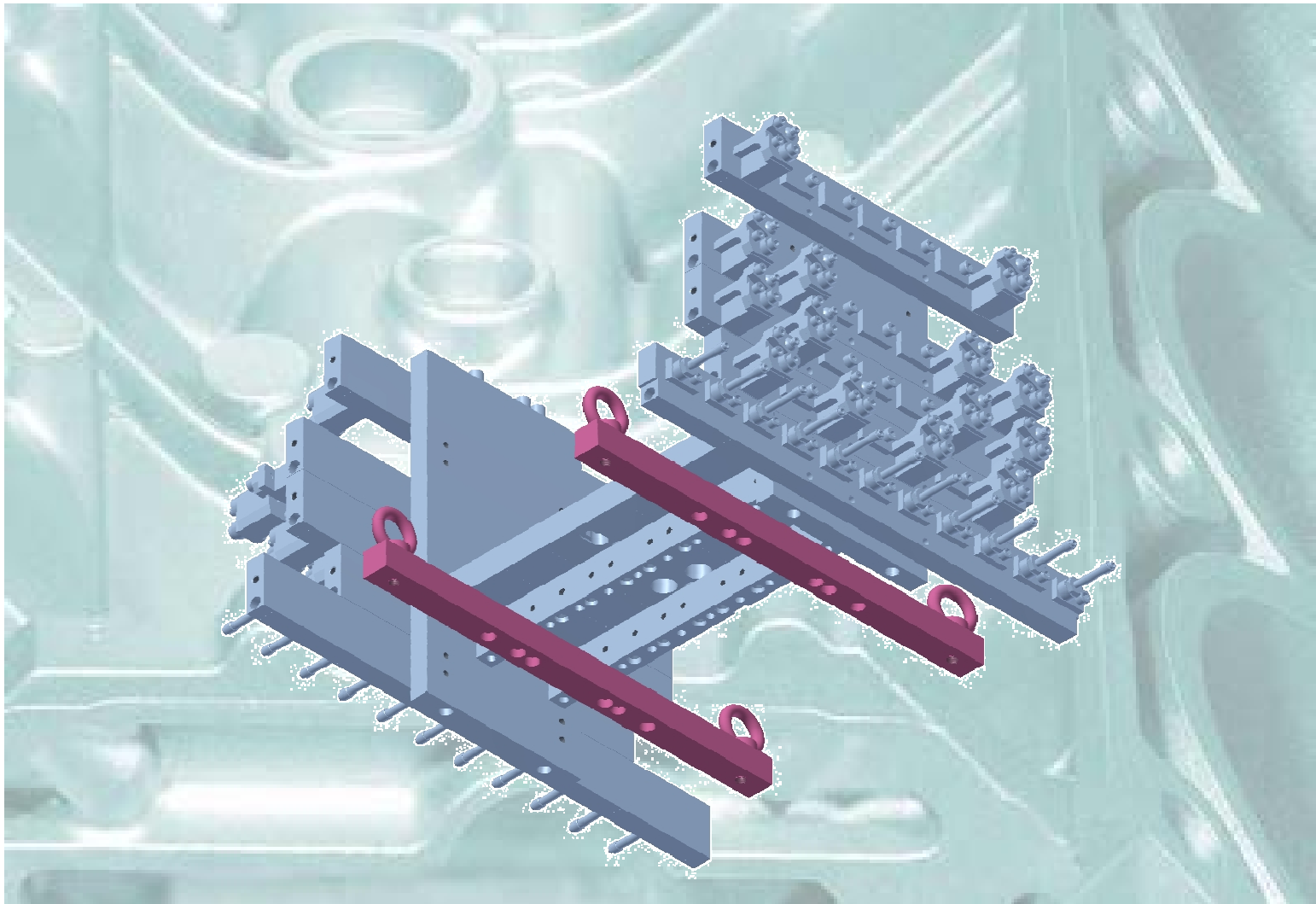

Artikelgruppe 110 Handling, Versteifung, etc.
 prod.group 110 handling / strengthening / etc

110.11 Artikelnr./ partno.801343		
Verstärkungsleiste Länge : 180 mm Reinforcing strip length = 180 mm		
110.12 Artikelnr./ partno.801509		
Befestigungsleiste für Versteifung B=450mm attachment strip for reinforcing B= 450mm		
110.13 Artikelnr./ partno.801513		
Verstärkungsleiste Länge : 700 mm Reinforcing strip length = 700 mm		
110.14 Artikelnr./ partno.801735		
Verstärkungsleiste Länge : 160 mm Reinforcing strip length = 160 mm		





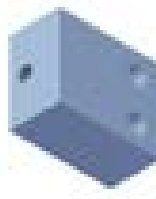





Artikelgruppe 120 Zubehör prod.group 120 addons





Artikelgruppe 120 Zubehör
 prod.group 120 addons

120.1 Artikelnr./ partno.22806		
<p>Ringschraube C15E M12 DIN580 verzinkt eye bolt C15E M12 DIN580 zinc coated</p>		
120.2 Artikelnr./ partno.301749		
<p>Düsenjustiergerät mit Laserpointer Nozzle adjustment unit with Laser</p>		
120.3 Artikelnr./ partno.325054		
<p>Flachstange 20x5mm ALU, natur eloxiert, Meterware flat bar 20x5mm aluminium, anodized, sold by metre</p>		
120.4 Artikelnr./ partno.800638		
<p>Befestigungsklotz Versteifungsleiste PS16-8/PS16-4 chock hardening strip PS16-8/PS16-4</p>		
120.5 Artikelnr./ partno.800783		
<p>Querleiste Anhängemöglichkeit für SWZ, Länge =500mm Cross strip for lift the tool length = 500 mm</p>		

Artikelgruppe 120 Zubehör
 prod.group 120 addons

120.6 Artikelnr./ partno.800977		
Befestigungsklotz Versteifungsleiste PS16-6 chock hardening strip PS16-6		
120.7 Artikelnr./ partno.801088		
Querleiste Anhängemöglichkeit für SWZ, Länge =700mm Cross strip for lift the tool length = 700 mm		
120.8 Artikelnr./ partno.801214		
Leiste für Transportpalette, PS16-8 Strip for transport rack; PS16-8		
120.9 Artikelnr./ partno.801381		
Leiste für Transportpalette, PS16-6 Strip for transport rack PS16-6		
120.10 Artikelnr./ partno.801462		
Leiste für Transportpalette, PS16-6, sonder Strip for transport rack PS16-6		

Artikelgruppe 120 Zubehör
prod.group 120 addons

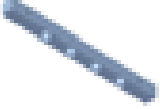
120.11 Artikelnr./ partno.801479		
Leiste für Transportpalette, PS16-8 (L=600mm) Strip for transport rack PS16-8		
120.12 Artikelnr./ partno.801512		
Leiste für Transportpalette, Befestigung auf Sprühleisten Strip for transport rack		

Inhaltsverzeichnis Table of Contents

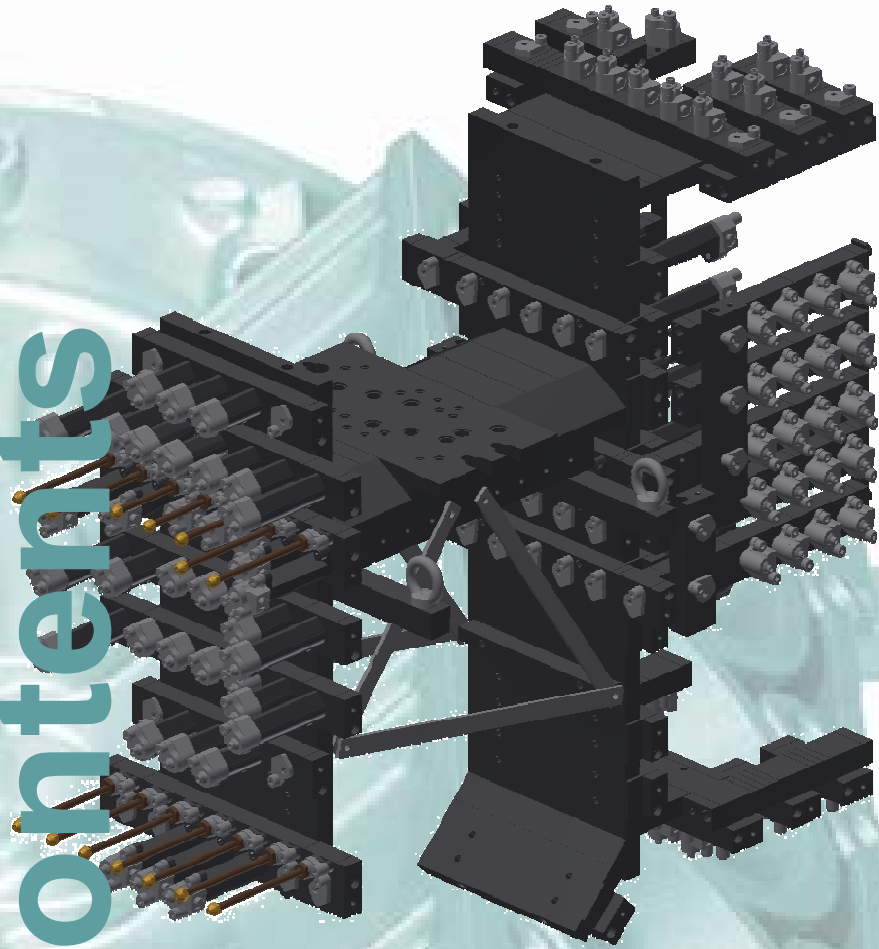

SPRÜHTECHNIK – PRODUKTKATALOG PS16c
SPRAY TECHNOLOGY – PRODUCT CATALOG PS16c

Artikelgruppe 000 Zwischenadapter
prod.group 000 intermediate adaptor

Pos	Beschreibung	Seite	Pos	description	Page
000.1	Zwischenadapter	3	000.1	intermediate adaptor	3
000.2	Zwischenadapter PS16-4/PSM2	3	000.2	intermediate adaptor PS16-4/PSM2	3
000.3	Spezialverteilerplatte	3	000.3	Special-distributor plate	3
000.4	Zwischenadapter PS16/PSM224	3	000.4	Intermediate adaptor PS16/PSM224	3
000.5	Zwischenadapter	3	000.5	intermediate adaptor PS16/PSM2	3
000.6	Zwischenplatte 8 zu 6Kreis	4	000.6	Intermediateplate 8 to 6	4
000.7	Spezialverteilerplatte	4	000.7	Special-distributor plate	4
000.8	Zwischenadapter Wollin an IDRA	4	000.8	Intermediate adaptor	4

Artikelgruppe 010 Adapter
prod.group 010 adaptor

Pos	Beschreibung	Seite	Pos	description	Page
010.1	Adapter PS16-6/SM-4Kreis/PSM-4Kreis	6	010.1	Adaptor PS16 - SM 4 circuit	6
010.2	Adapter PS16-6/PSM324/PSM336/PSM436	6	010.2	Adaptor PS16-6/PSM324/PSM336/PSM436	6
010.3	Adapter PS16/SM-2Kreis	6	010.3	Adaptor PS16/SM2 circuit	6
010.4	Adapter PS16-8/PSM448	6	010.4	Adaptor PS16-8/PSM448	6
010.5	Adapter PS16-6/PSM224	6	010.5	Adaptor PS16-6/PSM224	6
010.6	Adapter PS16-8/PSM448	7	010.6	Adaptor PS16-8/PSM448	7
010.7	Adapter PS16-6/PSM324-6/PSM336/PSM436/PSM3, schmal	7	010.7	Adaptor, narrow	7
010.8	Adapter PS16/PSM2	7	010.8	Adaptor PS16/PSM2	7
010.9	Adapter B3/F2 PS16/PSM2	7	010.9	Adaptor B3/F2 PS16/PSM2	7
010.10	Adapter PS16/PSM1	7	010.10	Adaptor PS16-6/PSM1	7
010.11	Adapter PS16/PSM2, schmal	8	010.11	Adaptor PS16/PSM2, narrow	8
010.12	Adapter PS16/PSM2	8	010.12	Adaptor PS16/PSM2	8

Artikelgruppe 011 Adaptermodule
prod.group 011 adaptor module

Pos	Beschreibung	Seite	Pos	description	Page
011.1	Adaptermodul 50mm	10	011.1	Adaptor module 50mm	10
011.2	Adaptermodul 25mm	10	011.2	Adaptor module 25mm	10
011.3	Adaptermodul 50mm	10	011.3	Adaptor module 50mm	10

Artikelgruppe 011 Adaptermodule
prod.group 011 adaptor module

Pos	Beschreibung	Seite	Pos	description	Page
011.4	Adaptermodul 25mm	10	011.4	Adaptor module 25mm	10
011.5	Adaptermodul 25mm, 90° gedreht	10	011.5	Adaptor module 25mm, 90° turned	10
011.6	Adaptermodul 50mm (>300)	11	011.6	Adaptor module 50mm (>300)	11
011.7	Adaptermodulabzweigung	11	011.7	Adaptor module junction	11
011.8	Adapterschliessleiste	11	011.8	Cover for adaptor	11
011.9	Adaptermodul 50mm, 90° gedreht	11	011.9	Adaptor module 50mm, turned 90°	11
011.10	Adaptermodul 50mm (>300)	11	011.10	Adaptor module 50mm (>300)	11
011.11	Adaptermodul 25mm, 90° gedreht	12	011.11	Adaptor module 25mm, 90° turned	12

Artikelgruppe 020 Verteilung Erweiterungen
prod.group 020 distibution additionalns

Pos	Beschreibung	Seite	Pos	description	Page
020.1	Verteilerumlenkung HO	14	020.1	Distributor deflection HO	14
020.2	Verteilerumlenkung HU	14	020.2	Distributor deflection HU	14
020.3	Verteilerdistanzmodul 60mm	14	020.3	Distribution distance module 60mm	14
020.4	Verteilerdistanzmodul 20mm	14	020.4	Distribution distance module 20mm	14
020.5	Verteilerschließplatte U	14	020.5	Distributor cover below	14
020.6	Verteilerschließplatte O	15	020.6	Distributor cover above	15
020.7	Verteilerschließplatte U	15	020.7	Distributor cover below	15
020.8	Verteilerschließplatte O	15	020.8	Distributor cover above	15
020.9	Verteilerdistanzmodul 60mm	15	020.9	Distribution distance module 60mm	15
020.10	Verteilerdistanzmodul 20mm	15	020.10	Distribution distance module 20mm	15
020.11	Verteilerumlenkung HO	16	020.11	Distributor deflection HO	16
020.12	Verteilerumlenkung HU	16	020.12	Distributor deflection HU	16
020.13	Verteileranschlußleiste	16	020.13	Distribution connection strip	16
020.14	Verteileranschlußleiste	16	020.14	Distribution connection strip	16
020.15	Verteilerumlenkung 45° VO	16	020.15	Distributor deflection 45° VO	16
020.16	Verteilerumlenkung 45° VU	17	020.16	Distributor deflection 45° VU	17
020.17	Verteilerumlenkung 45° VO	17	020.17	Distributor deflection 45° VU	17
020.18	Verteilerumlenkung 45° VU	17	020.18	Distributor deflection 45° VU	17
020.19	Verteilerumlenkung 45° HU	17	020.19	Distributor deflection 45° HU	17
020.20	Verteilerumlenkung 45° HO	17	020.20	Distributor deflection 45° HO	17
020.21	Verteilerumlenkung 45° HO	18	020.21	Distributor deflection 45° HO	18
020.22	Verteilerumlenkung 45° HU	18	020.22	Distributor deflection 45° HU	18
020.23	Verteilerdistanzmodul 15mm	18	020.23	Distribution distance module 15mm	18
020.24	Verteilerumlenkung VU mit Durchgang	18	020.24	Distributor deflection VU with pass	18
020.25	Verteilerumlenkung VO mit Durchgang	18	020.25	Distributor deflection VO with pass	18
020.26	Verteilerumlenkung VO mit Durchgang	19	020.26	Distributor deflection VO with pass	19

Artikelgruppe 020 Verteilung Erweiterungen
prod.group 020 distribution additional

Pos	Beschreibung	Seite	Pos	description	Page
020.27	Verteilerumlenkung VU mit Durchgang	19	020.27	Distributor deflection VU with pass	19
020.28	Verteilerschließplatte O	19	020.28	Distributor cover above	19
020.29	Verteilerschließplatte O	19	020.29	Distributor upper cover	19
020.30	Verteilerdistanzmodul 10mm	19	020.30	Distribution distance module 10mm	19

Artikelgruppe 021 Verteilung standard
prod.group 021 distribution standard

Pos	Beschreibung	Seite	Pos	description	Page
021.1	Verteilerleistenverschlußplatte	21	021.1	Distribution strip cover plate	21
021.2	Verteilerleistenverschlußplatte	21	021.2	Distribution strip cover plate	21
021.3	Verteilerleistenmodul	21	021.3	Distribution strip module	21
021.4	Verteilerleiste	21	021.4	distributionstrip	21
021.5	Verteilerleistenmodul	21	021.5	distribution strip module	21
021.6	Verteilerleiste	22	021.6	distribution strip	22

Artikelgruppe 022 Verteilung kompakt
prod.group 022 distribution compact

Pos	Beschreibung	Seite	Pos	description	Page
022.1	Verteilerleistenverschlußplatte (kompakt)	24	022.1	Distribution strip cover plate	24
022.2	Verteilerleistenmodul (kompakt)	24	022.2	Distribution strip module (compact)	24
022.3	Verteilerleistenmodul (kompakt)	24	022.3	Distribution strip module (compact)	24
022.4	Verteilerleiste (kompakt)	24	022.4	Distribution strip (compact)	24
022.5	Verteilerleistenmodul (kompakt)	24	022.5	Distribution strip (compact)	24
022.6	Verteilerleistenmodul (kompakt)	25	022.6	Distribution strip module (compact)	25
022.7	Verteilerleistenverschlußplatte (kompakt)	25	022.7	Distribution strip cover plate	25

Artikelgruppe 023 Verteilung kombi
prod.group 023 distribution combi

Pos	Beschreibung	Seite	Pos	description	Page
023.1	Verteilerleiste (kombi)	27	023.1	Distribution strip (combi)	27
023.2	Verteilerleiste (kombi)	27	023.2	Distribution strip (combi)	27
023.3	Verteilerleistenmodul (kombi)	27	023.3	Distribution strip module (combi)	27
023.4	Verteilerleistenmodul (kombi)	27	023.4	distribution strip module 60	27
023.5	Verteilerleistenmodul (kombi)	27	023.5	Distribution strip module (combi)	27

Artikelgruppe 023 Verteilung kombi
prod.group 023 distribution combi

Pos	Beschreibung	Seite	Pos	description	Page
023.6	Verteilerleistenmodul (kombi)	28	023.6	Distribution strip module (combi)	28
023.7	Verteilerleistenverschlußplatte (kombi)	28	023.7	Distribution strip cover plate	28
023.8	Verteilerleistenmodul (kombi)	28	023.8	Distribution strip module (combi)	28
023.9	Verteilerleistenmodul (kombi)	28	023.9	Distribution strip module (combi)	28

Artikelgruppe 024 Verteilung doppelt
prod.group 024 distribution double

Pos	Beschreibung	Seite	Pos	description	Page
024.1	Verteilerleiste (doppelt)	30	024.1	Distribution strip (double)	30
024.2	Verteilerleiste (doppelt)	30	024.2	Distribution strip (double)	30
024.3	Verteilerleistenmodul (doppelt)	30	024.3	Distribution strip module (double)	30
024.4	Verteilerleistenmodul (doppelt)	30	024.4	Distribution strip module (double)	30
024.5	Verteilerleistenmodul (doppelt)	30	024.5	Distribution strip module (double)	30
024.6	Verteilerleistenmodul (doppelt)	31	024.6	Distribution strip module (double)	31

Artikelgruppe 031 Sprühleisten kompakt
prod.group 031 spray strips compact

Pos	Beschreibung	Seite	Pos	description	Page
031.1	Kompaktsprühleiste 250mm Kreis 1/2	33	031.1	Combi spray strip module 50mm	33
031.2	Kompaktsprühleiste 250mm Kreis 3/4	33	031.2	Compact spray strip 250mm circuit 3/4	33
031.3	Kompaktsprühleiste 250mm Kreis 5/6	33	031.3	Compact spray strip 250mm circuit 5/6	33
031.4	Kompaktsprühleiste 250mm Kreis 7/8	33	031.4	Compact spray strip 250mm circuit 7/8	33
031.5	Kompaktsprühleiste 200mm Kreis 1/2	33	031.5	Compact spray strip 200mm circuit 1/2	33
031.6	Kompaktsprühleiste 200mm Kreis 3/4	34	031.6	Compact spray strip 200mm circuit 3/4	34
031.7	Kompaktsprühleiste 200mm Kreis 5/6	34	031.7	Compact spray strip 200mm circuit 5/6	34
031.8	Kompaktsprühleiste 170mm Kreis 1/2	34	031.8	Compact spray strip 170mm circuit 1/2	34

Artikelgruppe 032 Sprühleisten kombi
prod.group 032 spray strips combi

Pos	Beschreibung	Seite	Pos	description	Page
032.1	Kombisprühleiste 250mm Kreis 1/2	36	032.1	Combi spray strip 250mm circuit 1/2	36
032.2	Kombisprühleiste 250mm Kreis 3/4	36	032.2	Combi spray strip 250mm circuit 3/4	36
032.3	Kombisprühleiste 250mm Kreis 5/6	36	032.3	Combi spray strip 250mm circuit 5/6	36
032.4	Kombisprühleiste 250mm Kreis 7/8	36	032.4	Combi spray strip 250mm circuit 7/8	36

SPRÜHTECHNIK – PRODUKTKATALOG PS16c
SPRAY TECHNOLOGY – PRODUCT CATALOG PS16c

Artikelgruppe 032 Sprühleisten kombi
prod.group 032 spray strips combi

Pos	Beschreibung	Seite	Pos	description	Page
032.5	Kombisprühleiste 250mm Kreis 1/2	36	032.5	Combi spray strip 250mm circuit 1/2	36
032.6	Kombisprühleiste 250mm Kreis 3/4	37	032.6	Combi spray strip 250mm circuit 3/4	37

Artikelgruppe 033 Sprühleisten doppelt
prod.group 033 spray strips double

Pos	Beschreibung	Seite	Pos	description	Page
033.1	Doppelsprühleiste 250mm Kreis 1/2-Kreis 3/4	39	033.1	Double spray strip 250mm circuit 1/2-circuit 3/4	39
033.2	Doppelsprühleiste 250mm Kreis 1/2-Kreis 5/6	39	033.2	Double spray strip 250mm circuit 1/2-circuit 5/6	39
033.3	Doppelsprühleiste 250mm Kreis 1/2-Kreis 7/8	39	033.3	Double spray strip 250mm circuit 1/2-circuit 7/8	39
033.4	Doppelsprühleiste 250mm Kreis 3/4-Kreis 5/6	39	033.4	Double spray strip 250mm circuit 3/4-circuit 5/6	39
033.5	Doppelsprühleiste 250mm Kreis 3/4-Kreis 7/8	39	033.5	Double spray strip 250mm circuit 3/4-circuit 7/8	39
033.6	Doppelsprühleiste 250mm Kreis 5/6-Kreis 7/8	40	033.6	Double spray strip 250mm circuit 5/6-circuit 7/8	40
033.7	Doppelsprühleiste 250mm Kreis 3/4-Kreis 1/2	40	033.7	Double spray strip 250mm circuit 3/4-circuit 1/2	40
033.8	Doppelsprühleiste 250mm Kreis 7/8-Kreis 5/6	40	033.8	Double spray strip 250mm circuit 5/6-circuit 7/8	40

Artikelgruppe 034 Blasleisten kompakt
prod.group 034 blast strips compact

Pos	Beschreibung	Seite	Pos	description	Page
034.1	Blasleiste 250mm	42	034.1	Blasting strip 250mm	42

Artikelgruppe 035 Blasleiste (23mm)
prod.group 035 blast strips (23mm)

Pos	Beschreibung	Seite	Pos	description	Page
035.1	Verteilerblasleiste 23mm	44	035.1	Distribution blasting strip 23mm	44
035.2	Verteilerblanschliessleiste L	44	035.2	Distribution blasting strip cover left	44
035.3	Verteilerblanschliessleiste R	44	035.3	Distribution blasting strip cover right	44
035.4	Blasleistenmodul 50mm	44	035.4	Blasting strip module 50mm	44
035.5	Blasleistenmodul 100mm	44	035.5	Blasting strip module 100mm	44
035.6	Verteilerblasleiste 23mm	45	035.6	Distibution blasting strip 23mm	45
035.7	Verteilerblasleiste 23mm	45	035.7	Distribution blasting strip 23mm	45
035.8	Verteilerblasleiste 23mm	45	035.8	Distribution blasting strip 23mm	45
035.9	Blasabschlußleiste 50mm links	45	035.9	Left end blasting strip module 50mm	45
035.10	Verteilerblasleiste 23mm	45	035.10	Distribution blasting strip 23mm	45
035.11	Blasleistenumlenkung mit Durchgang	46	035.11	Blasting strip deflection with pass	46

SPRÜHTECHNIK – PRODUKTKATALOG PS16c
SPRAY TECHNOLOGY – PRODUCT CATALOG PS16c

Artikelgruppe 035 Blasleiste (23mm)
prod.group 035 blast strips (23mm)

Pos	Beschreibung	Seite	Pos	description	Page
035.12	Blasabschlußleiste 50mm rechts	46	035.12	Right end blasting strip module 50mm	46
035.13	Blasleistendistanzmodul 15mm	46	035.13		46
035.14	Verteilerblasleiste 23mm	46	035.14	Distribution blasting strip 23mm	46
035.15	Verteilerblasleiste 23mm	46	035.15	Distribution blasting strip 23mm	46

Artikelgruppe 040 Sprüh-/Blasleisten Erweit. standard
prod.group 040 spray-/blast strips add. standard

Pos	Beschreibung	Seite	Pos	description	Page
040.1	Sprüh-/Blasleistenmodul 50mm	48	040.1	Spray and blasting strip modul 50mm	48

Artikelgruppe 041 Sprühleisten Erweiterung kompakt
prod.group 041 spray strips additional compact

Pos	Beschreibung	Seite	Pos	description	Page
041.1	Kompaktsprühleistenmodul 100mm	50	041.1	Compact spray strip module 100mm	50
041.2	Kompaktsprühleistenschliessleiste R	50	041.2	Cover for compact spray strip R	50
041.3	Kompaktsprühleistenschliessleiste L	50	041.3	Cover for compact spray strip L	50
041.4	Kompaktsprühleistenmodul 50mm	50	041.4	Compact spray strip module 50mm	50
041.5	Kompaktsprühleistenkreuzung	50	041.5	Compact spray strip junction	50
041.6	Kompaktsprühleistenwinkel 1	51	041.6	Angle 1 for compact spray strips	51
041.7	Kompaktsprühleistenwinkel 2	51	041.7	Angle 2 for compact spray strips	51
041.8	Kompaktsprühleistenwinkel 3	51	041.8	Angle 3 for compact spray strips	51
041.9	Kompaktsprühleistenwinkel 4	51	041.9	Angle 4 for compact spray strips	51
041.10	Kompaktsprühleistendistanzmodul 100mm	51	041.10	Compact spray strip spacer modul 100mm	51
041.11	Kompaktsprühleistendistanzmodul 50mm	52	041.11	Compact spray strip spacer modul 50mm	52
041.12	Kompaktsprühleistenwinkelstück 45°LHA	52	041.12	Compact spray strip angled piece 45°LHA	52
041.13	Kompaktsprühleistenwinkelstück 45°LVI	52	041.13	Compact spray strip angled piece 45°LVI	52
041.14	Kompaktsprühleistenwinkelstück 45°RHA	52	041.14	Compact spray strip angled piece 45°RHA	52
041.15	Kompaktsprühleistenwinkelstück 45°RVI	52	041.15	Compact spray strip angled piece 45°RVI	52
041.16	Kompaktsprühleistendistanzmodul 10mm	53	041.16	Compact spray strip spacer module 10mm	53
041.17	Kompaktsprühleisten-Inversmodul o.O-R	53	041.17	Compact spray strip inverse module	53
041.18	Kompaktsprühleisten-Inversmodul m.O-R	53	041.18	Compact spray strip inverse module	53
041.19	Kompaktsprühleistendistanzmodul 15mm	53	041.19	Compact spray strip spacer module 10mm	53
041.20	Kompaktsprühabschlußleiste 50mm rechts	53	041.20	Right end compact spray strip module 50mm	53
041.21	Kompaktsprühabschlußleiste 50mm links	54	041.21	Left end compact spray strip module 50mm	54

Artikelgruppe 042 Sprühleisten Erweiterung kombi
prod.group 042 spray strips additional combi

Pos	Beschreibung	Seite	Pos	description	Page
042.1	Kombisprühleistenmodul 100mm	56	042.1	Combi spray strip module 100mm	56

SPRÜHTECHNIK – PRODUKTKATALOG PS16c
SPRAY TECHNOLOGY – PRODUCT CATALOG PS16c

Artikelgruppe 042 Sprühleisten Erweiterung kombi
prod.group 042 spray strips additional combi

Pos	Beschreibung	Seite	Pos	description	Page
042.2	Kombisprühleistenschliessleiste R	56	042.2	Cover for combi spray strip R	56
042.3	Kombisprühleistenschliessleiste L	56	042.3	Cover for combi spray strip L	56
042.4	Kombisprühleistenmodul 50mm	56	042.4	Combi spray strip module 50mm	56
042.5	Kombisprühleistenkreuzung	56	042.5	Combi spray strip junction	56
042.6	Kombisprühleistenwinkel 1	57	042.6	Angle 1 for combi spray strips	57
042.7	Kombisprühleistenwinkel 2	57	042.7	Angle 2 for combi spray strips	57
042.8	Kombisprühleistenwinkel 3	57	042.8	Angle 3 for combi spray strips	57
042.9	Kombisprühleistenwinkel 4	57	042.9	Angle 4 for combi spray strips	57
042.10	Kombisprühleistendistanzmodul 100mm	57	042.10	Combi spray strip spacer module 100mm	57
042.11	Kombisprühleistendistanzmodul 50mm	58	042.11	Combi spray strip spacer module 50mm	58
042.12	Kombisprühleistenwinkelstück 45°LHA	58	042.12	Combi spray strip angled piece 45°LHA	58
042.13	Kombisprühleistenwinkelstück 45°LVI	58	042.13	Combi spray strip angled piece 45°LVI	58
042.14	Kombisprühleistenwinkelstück 45°RHA	58	042.14	Combi spray strip angled piece 45°RHA	58
042.15	Kombisprühleistenwinkelstück 45°RVI	58	042.15	Combi spray strip angled piece 45°RVI	58
042.16	Kombisprühleistendistanzmodul 10mm	59	042.16	Combi spray strip spacer module 10mm	59
042.17	Kombisprühleisten-Inversmodul o.O-R	59	042.17	Combi spray strip inverse module	59
042.18	Kombisprühleisten-Inversmodul m.O-R	59	042.18	Combi spray strip inverse module	59
042.19	Kombisprühabschlußleiste 50mm rechts	59	042.19	Right end combispray strip module 50mm	59
042.20	Kombisprühabschlußleiste 50mm links	59	042.20	Left end combispray strip module 50mm	59
042.21	Kombisprühleistenmodul 50mm	60	042.21	Combi spray strip module 50mm	60

Artikelgruppe 043 Sprühleisten Erweiterung doppelt
prod.group 043 spray strips additional double

Pos	Beschreibung	Seite	Pos	description	Page
043.1	Doppelsprühleistenmodul 100mm	62	043.1	Double spray strip module 100mm	62
043.2	Doppelsprühleistenschliessleiste R	62	043.2	Cover for double spray strip R	62
043.3	Doppelsprühleistenschliessleiste L	62	043.3	Cover for double spray strip L	62
043.4	Doppelsprühleistenmodul 50mm	62	043.4	Double spray strip module 50mm	62
043.5	Doppelsprühleistenwinkel 1	62	043.5	Angle 1 for double spray strips	62
043.6	Doppelsprühleistenwinkel 2	63	043.6	Angle 2 for double spray strips	63
043.7	Doppelsprühleistenwinkel 3	63	043.7	Angle 3 for double spray strips	63
043.8	Doppelsprühleistenwinkel 4	63	043.8	Angle 4 for double spray strips	63
043.9	Doppelsprühleistendistanzmodul 100mm	63	043.9	Double spray strip spacer modul 100mm	63
043.10	Doppelsprühleistendistanzmodul 50mm	63	043.10	Double spray strip spacer module 50mm	63
043.11	Doppelsprühleistenwinkelstück 45°LHA	64	043.11	Double spray strip angled piece 45°LHA	64
043.12	Doppelsprühleistenwinkelstück 45°LVI	64	043.12	Double spray strip angled piece 45°LVI	64
043.13	Doppelsprühleistenwinkelstück 45°RHA	64	043.13	Double spray strip angled piece 45°RHA	64
043.14	Doppelsprühleistenwinkelstück 45°RVI	64	043.14	Double spray strip angled piece 45°RVI	64

Artikelgruppe 043 Sprühleisten Erweiterung doppelt
prod.group 043 spray strips additional double

Pos	Beschreibung	Seite	Pos	description	Page
043.15	Doppelsprühleistendistanzmodul 10mm	64	043.15	Double spray strip spacer module 10mm	64
043.16	Doppelsprühleisten-Inversmodul	65	043.16	Double spray strip inverse module	65

Artikelgruppe 044 Blasleisten Erweiterung kompakt
prod.group 044 blast strips additional compact

Pos	Beschreibung	Seite	Pos	description	Page
044.1	Blasleistenmodul 100mm	67	044.1	Blasting strip module 100mm	67
044.2	Blasleistenmodul 50mm	67	044.2	Blasting strip module 50mm	67
044.3	Blasleistenschliessleiste R (kompakt)	67	044.3	Cover for compact blasting strip R	67
044.4	Blasleistenschliessleiste L (kompakt)	67	044.4	Cover for compact blasting strip L	67
044.5	Blasleistenkreuzung	67	044.5	Blasting strip junction	67
044.6	Blasleistenwinkel 1	68	044.6	Angle 1 for blast strip 45	68
044.7	Blasleistenwinkel 2	68	044.7	angle 2 for blasting strip 45	68
044.8	Blasleistenwinkel 3	68	044.8	Angle 3 for blast strip 45	68
044.9	Blasleistenwinkel 4	68	044.9	Angle 4 for blast strip 45	68
044.10	Blasleistendistanzmodul 100mm	68	044.10	Blasting strip spacer module 100mm	68
044.11	Blasleistendistanzmodul 50mm	69	044.11	Blasting strip spacer module 50mm	69
044.12	Blasleistenwinkelstück 45°LHA	69	044.12	Blasting strip angled piece 45°LHA	69
044.13	Blasleistenwinkelstück 45°LVI	69	044.13	Blasting strip angled piece 45°LVI	69
044.14	Blasleistenwinkelstück 45°RHA	69	044.14	Blasting strip angled piece 45°RHA	69
044.15	Blasleistenwinkelstück 45°RVI	69	044.15	Blasting strip angled piece 45°RVI	69
044.16	Blasleistendistanzmodul 10mm	70	044.16	Blasting strip spacer module 10mm	70
044.17	Blasleisten-Inversmodul o.O-R	70	044.17	Blasting strip inverse module	70
044.18	Blasleisten-Inversmodul m.O-R	70	044.18	Blasting strip inverse module	70

Artikelgruppe 050 Sprühdüsen außenmisch
prod.group 050 spray nozzles outside mixing

Pos	Beschreibung	Seite	Pos	description	Page
050.1	Sprühdüse SD14	72	050.1	Spray nozzle SD14	72
050.2	Sprühdüse SD14 Basis	72	050.2	Spray nozzle SD14 carrier	72
050.3	Sprühdüse SD14	72	050.3	Spray nozzle	72
050.4	Sprühdüse SD14	72	050.4	Spray nozzle	72
050.5	Sprühdüse SD14	72	050.5	Spray nozzle	72
050.6	Sprühdüse SD14	73	050.6	Spray nozzle	73
050.7	Sprühdüse SD14	73	050.7	Spray nozzle	73
050.8	Sprühdüse SD14	73	050.8	Spray nozzle	73

Artikelgruppe 050 Sprühdüsen außenmisch
prod.group 050 spray nozzles outside mixing

Pos	Beschreibung	Seite	Pos	description	Page
050.9	Sprühdüse SD14	73	050.9	Spray nozzle	73
050.10	Sprühdüse SD14	73	050.10	Spray nozzle	73

Artikelgruppe 070 Blasdüsen
prod.group 070 blast nozzles

Pos	Beschreibung	Seite	Pos	description	Page
070.1	Blas-Set mit KD-I-30 (100mm lang)	75	070.1	Blasting set with KD-I-30 (100mm)	75
070.2	Blas-Set mit KD-I-26	75	070.2	Blasting set with KD-I-26	75
070.3	Blas-Set mit KD-I-30	75	070.3	Blasting set with KD-I-30	75
070.4	Blas-Set mit KD-I-26 (50mm lang)	75	070.4	Blasting set with KD-I-26 (50mm)	75
070.5	Blas-Set mit KD-I-20	75	070.5	Blasting set with KD-I-20	75

Artikelgruppe 080 ECO-Spray Düsen
prod.group 080 ECO-spray nozzles

Pos	Beschreibung	Seite	Pos	description	Page
080.1	Dosierdüse	77	080.1	Dosing nozzle	77
080.2	Dosierdüse Basis	77	080.2	dosing nozzle carrier	77
080.3	Dosierdüse	77	080.3	Dosing nozzle	77
080.4	Dosierdüse Basis	77	080.4	dosing nozzle carrier	77
080.5	Dosierdüse	77	080.5	Dosing nozzle	77
080.6	Dosierdüse Basis	78	080.6	dosing nozzle carrier	78
080.7	Dosierdüse	78	080.7	Dosing nozzle	78
080.8	Dosierdüse	78	080.8	Dosing nozzle	78
080.9	Dosierdüse Basis	78	080.9	Dosing nozzle carrier	78
080.10	Dosierdüse	78	080.10	Dosing nozzle	78
080.11	Dosierdüse	79	080.11	Dosing nozzle	79
080.12	Dosierdüse Basis	79	080.12	Dosing nozzle carrier	79
080.13	Kappe mit Festanschlag 1	79	080.13	Cap with fixed stop 1	79
080.14	Kappe mit Festanschlag 2	79	080.14	Cap with fixed stop 2	79
080.15	Kappe mit Festanschlag 3	79	080.15	Cap with fixed stop 3	79
080.16	Kappe mit Festanschlag 4	80	080.16	Cap with fixed stop 4	80
080.17	Kappe mit Festanschlag 5	80	080.17	Cap with fixed stop 5	80
080.18	Kappe mit Festanschlag 6	80	080.18	Cap with fixed stop 6	80
080.19	Dosierdüse Basis	80	080.19	Dosing nozzle carrier	80
080.20	Sprühdüse FSD	80	080.20	Spray nozzle FSD	80
080.21	Sprühdüse FSD	81	080.21	Spray nozzle FSD	81

SPRÜHTECHNIK – PRODUKTKATALOG PS16c
SPRAY TECHNOLOGY – PRODUCT CATALOG PS16c

Artikelgruppe 080 ECO-Spray Düsen
prod.group 080 ECO-spray nozzles

Pos	Beschreibung	Seite	Pos	description	Page
080.22	Sprühdüse FSD Basis	81	080.22	Spray nozzle FSD basis	81
080.23	Sprühdüse FSD	81	080.23	Spray nozzle FSD	81

Artikelgruppe 090 Zubehör außenmisch
prod.group 090 addons outside mixing

Pos	Beschreibung	Seite	Pos	description	Page
090.1	Rohr	83	090.1	Tube	83
090.2	Rohr	83	090.2	Tube	83
090.3	Rohr	83	090.3	Tube	83
090.4	Rohr	83	090.4	Tube	83
090.5	Rohr	83	090.5	Tube	83
090.6	Rohrenddüse	84	090.6	Nozzle for tube	84
090.7	Verschluss für Sprührohr AM	84	090.7	blind plug	84
090.8	Umlenkung 90°	84	090.8	Direction change 90°	84
090.9	T-Umlenkung	84	090.9	T-direction change	84
090.10	L-Umlenkung	84	090.10	L-direction change	84

Artikelgruppe 091 Zubehör außenmisch/ECO-Spray
prod.group 091 addons outside mixing/ECO-spray

Pos	Beschreibung	Seite	Pos	description	Page
091.1	Kugeldüse	86	091.1	Ball nozzle	86
091.2	Kugeldüse	86	091.2	Ball nozzle	86
091.3	Kugeldüse	86	091.3	Ball nozzle	86
091.4	Kugeldüse	86	091.4	Ball nozzle	86
091.5	Kugeldüse	86	091.5	Ball nozzle	86
091.6	Kugeldüse	87	091.6	Ball nozzle	87
091.7	Kugeldüse	87	091.7	Ball nozzle	87
091.8	Kugeldüse	87	091.8	Ball nozzle	87
091.9	Kugeldüse	87	091.9	Ball nozzle	87
091.10	Kugeldüse	87	091.10	Ball nozzle	87

Artikelgruppe 092 Zubehör innenmisch/blasen
prod.group 092 addons inside/blast mixing

Pos	Beschreibung	Seite	Pos	description	Page
092.1	Kugeldüse	89	092.1	Ball nozzle	89

Artikelgruppe 092 Zubehör innenmisch/blasen
prod.group 092 addons inside/blast mixing

Pos	Beschreibung	Seite	Pos	description	Page
092.2	Rohr	89	092.2	Tube	89
092.3	Rohr	89	092.3	Tube	89
092.4	Rohrenddüse	89	092.4	Nozzle for tube	89
092.5	Rohrenddüse	89	092.5	Nozzle for tube	89
092.6	Rohr	90	092.6	Tube	90
092.7	Rohr	90	092.7	Tube	90
092.8	Rohr	90	092.8	Tube	90
092.9	Kugeldüse	90	092.9	Ball nozzle	90
092.10	Rohrenddüse	90	092.10	Nozzle for tube	90
092.11	Rohr	91	092.11	Tube	91
092.12	Kugeldüse	91	092.12	Ball nozzle	91
092.13	Kugeldüse	91	092.13	Ball nozzle	91
092.14	Kugeldüse	91	092.14	Ball nozzle	91
092.15	Rohr	91	092.15	Tube	91
092.16	Rohr	92	092.16	Tube	92
092.17	Rohr	92	092.17	Tube	92
092.18	Rohr	92	092.18	Tube	92
092.19	Rohr	92	092.19	Tube	92
092.20	Rohr	92	092.20	Tube	92
092.21	Umlenkung 90°	93	092.21	Direction change 90°	93
092.22	Kugeldüse	93	092.22	Ballnozzle	93
092.23	Kugeldüse	93	092.23	Ballnozzle	93
092.24	Kugeldüse	93	092.24	Ball nozzle	93
092.25	Kugeldüse	93	092.25	Ball nozzle	93
092.26	Rohrenddüse	94	092.26	Nozzle for tube	94
092.27	Rohrenddüse	94	092.27	Nozzle for tube	94
092.28	Rohrenddüse	94	092.28	Nozzle for tube	94
092.29	Rohrenddüse	94	092.29	Nozzle for tube	94
092.30	Rohrenddüse	94	092.30	Nozzle for tube	94

Artikelgruppe 093 Zubehör blasen
prod.group 093 addons blast

Pos	Beschreibung	Seite	Pos	description	Page
093.1	Halteplatte für Rohr auf Blasleiste	96	093.1	Holding plate for tube	96
093.2	Verschuß (Blindplatte Blasdüse)	96	093.2	Cover for blasting exit	96
093.3	Blasdüsenerhöhung 50mm	96	093.3	Blasting nozzle extension 50mm	96
093.4	Blasdüsenerhöhung 100mm	96	093.4	Blasting nozzle extension 100mm	96

Artikelgruppe 094 Zubehör außenmisch/innenmisch
prod.group 094 addons outside/inside mixing

Pos	Beschreibung	Seite	Pos	description	Page
094.1	Dosierblende	98	094.1	Dosing insert	98

SPRÜHTECHNIK – PRODUKTKATALOG PS16c
SPRAY TECHNOLOGY – PRODUCT CATALOG PS16c

Artikelgruppe 094 Zubehör außenmisch/innenmisch
prod.group 094 addons outside/inside mixing

Pos	Beschreibung	Seite	Pos	description	Page
094.2	Dosierblende	98	094.2	Dosing insert	98
094.3	Dosierblende	98	094.3	Dosing insert	98
094.4	Dosierblende	98	094.4	Dosing insert	98
094.5	Dosierblende	98	094.5	Dosing insert	98
094.6	Dosierblende	99	094.6	Dosing insert	99
094.7	Dosierblende	99	094.7	Dosing insert	99
094.8	Dosierblende	99	094.8	Dosing insert	99
094.9	Verschluß (Blindplatte Sprühdüse)	99	094.9	Cover plate	99
094.10	Dosierblende	99	094.10	Dosing insert	99
094.11	Dosierblende	100	094.11	Dosing insert	100

Artikelgruppe 095 Zubehör außen-/innenmisch/blasen
prod.group 095 addons outside/inside mixing blast

Pos	Beschreibung	Seite	Pos	description	Page
095.1	Klemmdeckel für Kugeldüse	102	095.1	Clamp plate for ball nozzle	102
095.2	Halteplatte für Rohr	102	095.2	Holding plate for tube	102

Artikelgruppe 096 Zubehör außen-/innenmisch/ECO-Spray
prod.group 096 addons outside/inside mixing/ECO

Pos	Beschreibung	Seite	Pos	description	Page
096.1	Sprühdüsenerhöhung 50mm	104	096.1	Spray nozzle extension 50mm	104
096.2	Sprühdüsenerhöhung 100mm	104	096.2	Spray nozzle extension 100mm	104
096.3	Adapterplatte für Sprühdüse	104	096.3	Adaptor plate for spray nozzle	104

Artikelgruppe 097 Zubehör ECO-Spray
prod.group 097 addons ECO-spray

Pos	Beschreibung	Seite	Pos	description	Page
097.1	Halteplatte für Rohr	106	097.1	Holding plate	106
097.2	Klemmdeckel für Kugeldüse	106	097.2	Clamp plate for ball nozzle	106

Artikelgruppe 100 Sonderteile
prod.group 100 special parts

Pos	Beschreibung	Seite	Pos	description	Page
100.1	Adaptermodul 50mm	108	100.1	Adaptor module 50mm	108

Artikelgruppe 100 Sonderteile
prod.group 100 special parts

Pos	Beschreibung	Seite	Pos	description	Page
100.2	Verteilerschließplatte O	108	100.2	Endplate upside	108
100.3	Adaptermodul 25mm	108	100.3	Adaptor module 25mm	108
100.4	Kompaktsprühleiste 200mm Kreis 3/4-Kreis 5/6	108	100.4	Compact spray strip 200mm circuit 3/4-circuit 5/6	108
100.5	Kompaktsprühleiste 225mm Kreis 5/6	108	100.5	Spray strip 225mm circuit 5/6	108
100.6	Kompaktsprühleistenmodul 45mm	109	100.6	Compact spray strip module 45mm	109
100.7	Verteilerschließplatte U	109	100.7	Distributor cover below	109

Artikelgruppe 110 Handling, Versteifung, etc.
prod.group 110 handling / strengthening / etc

Pos	Beschreibung	Seite	Pos	description	Page
110.1	Verstärkungsleiste	111	110.1	Reinforcing strip	111
110.2	Verstärkungsleiste	111	110.2	Reinforcing strip	111
110.3	Verstärkungsleiste	111	110.3	Reinforcing strip	111
110.4	Verstärkungsleiste	111	110.4	Reinforcing strip	111
110.5	Verstärkungsleiste	111	110.5	Reinforcing strip	111
110.6	Befestigungsleiste	112	110.6	attachment strip	112
110.7	Befestigungsleiste	112	110.7	attachment strip	112
110.8	Verstärkungsleiste	112	110.8	Reinforcing strip	112
110.9	Befestigungsleiste	112	110.9	attachment strip	112
110.10	Verstärkungsleiste	112	110.10	Reinforcing strip	112
110.11	Verstärkungsleiste	113	110.11	Reinforcing strip	113
110.12	Befestigungsleiste	113	110.12	attachment strip	113
110.13	Verstärkungsleiste	113	110.13	Reinforcing strip	113
110.14	Verstärkungsleiste	113	110.14	Reinforcing strip	113

Artikelgruppe 120 Zubehör
prod.group 120 addons

Pos	Beschreibung	Seite	Pos	description	Page
120.1	Ringschraube C15E M12 DIN580	115	120.1	eye bolt C15E M12 DIN580	115
120.2	Düsenjustiergerät	115	120.2	Nozzle adjustment unit	115
120.3	Flachstange 20x5mm	115	120.3	flat bar 20x5mm	115
120.4	Befestigungsklotz	115	120.4	chock	115
120.5	Querleiste	115	120.5	Cross strip for lift the tool	115
120.6	Befestigungsklotz	116	120.6	chock	116
120.7	Querleiste	116	120.7	Cross strip for lift the tool	116
120.8	Leiste	116	120.8	Strip	116

Artikelgruppe 120 Zubehör
prod.group 120 addons

Pos	Beschreibung	Seite	Pos	description	Page
120.9	Leiste	116	120.9	Strip for transport rack	116
120.10	Leiste	116	120.10	Strip for transport rack	116
120.11	Leiste	117	120.11	Strip for transport rack	117
120.12	Leiste	117	120.12	Strip	117