

PS16CXL

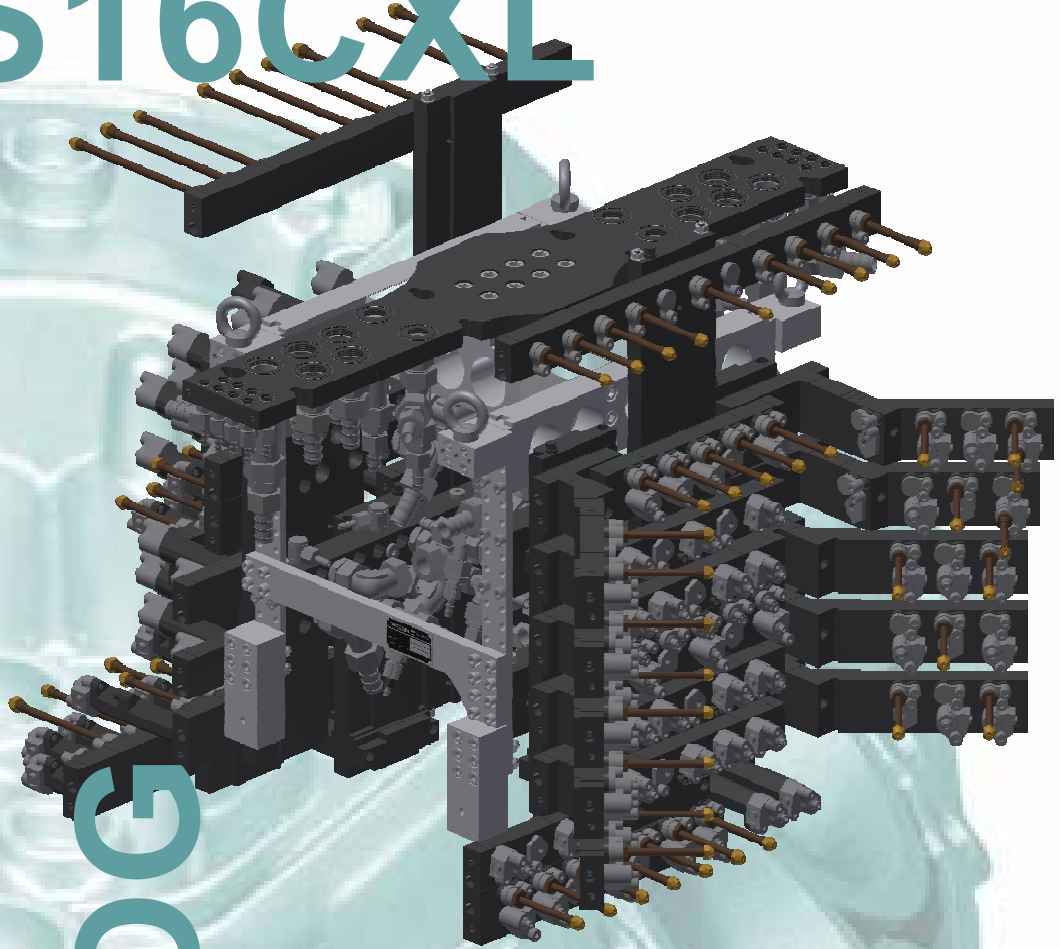

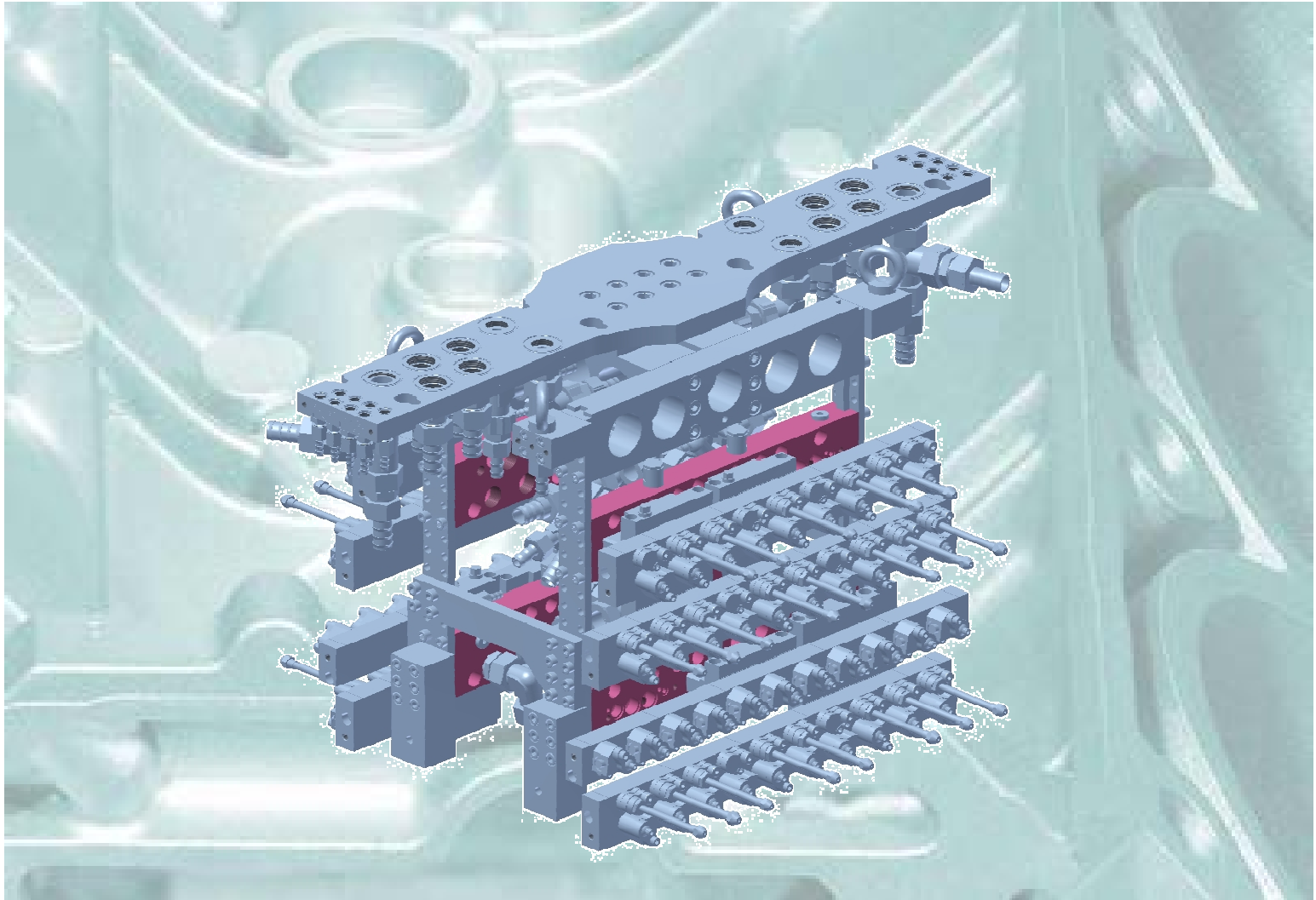

KATALOG KATALOG

Artikelgruppe 10 Zubehör prod.group 10 addons









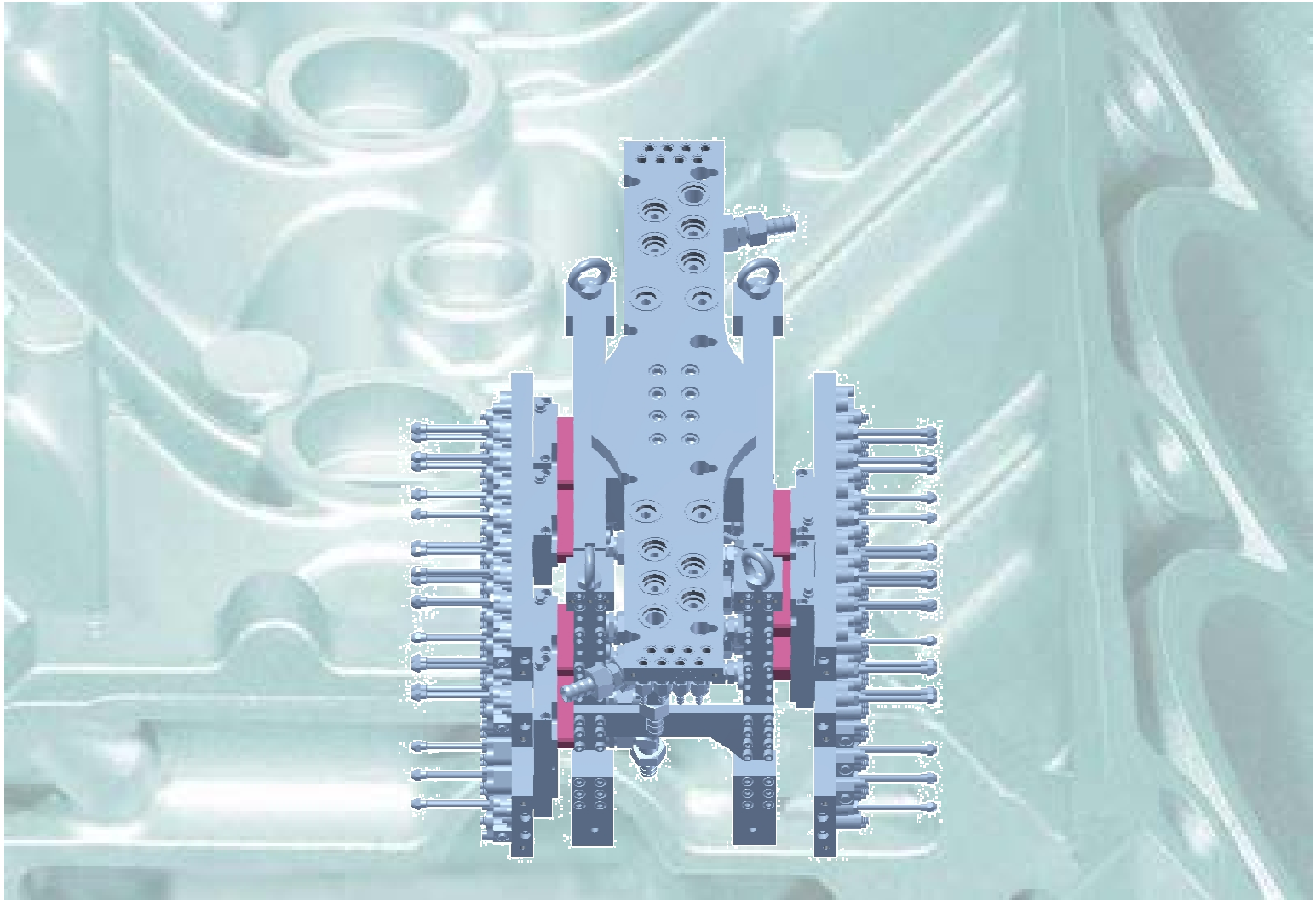



Artikelgruppe 10 Zubehör
prod.group 10 addons

010.1 Artikelnr./ partno.801352		
Anschlussleiste 3-fach PS16CXL, komplett Terminal strip 3-fold PS16CXL, complete		

Artikelgruppe 11 Zubehör prod.group 11 addons









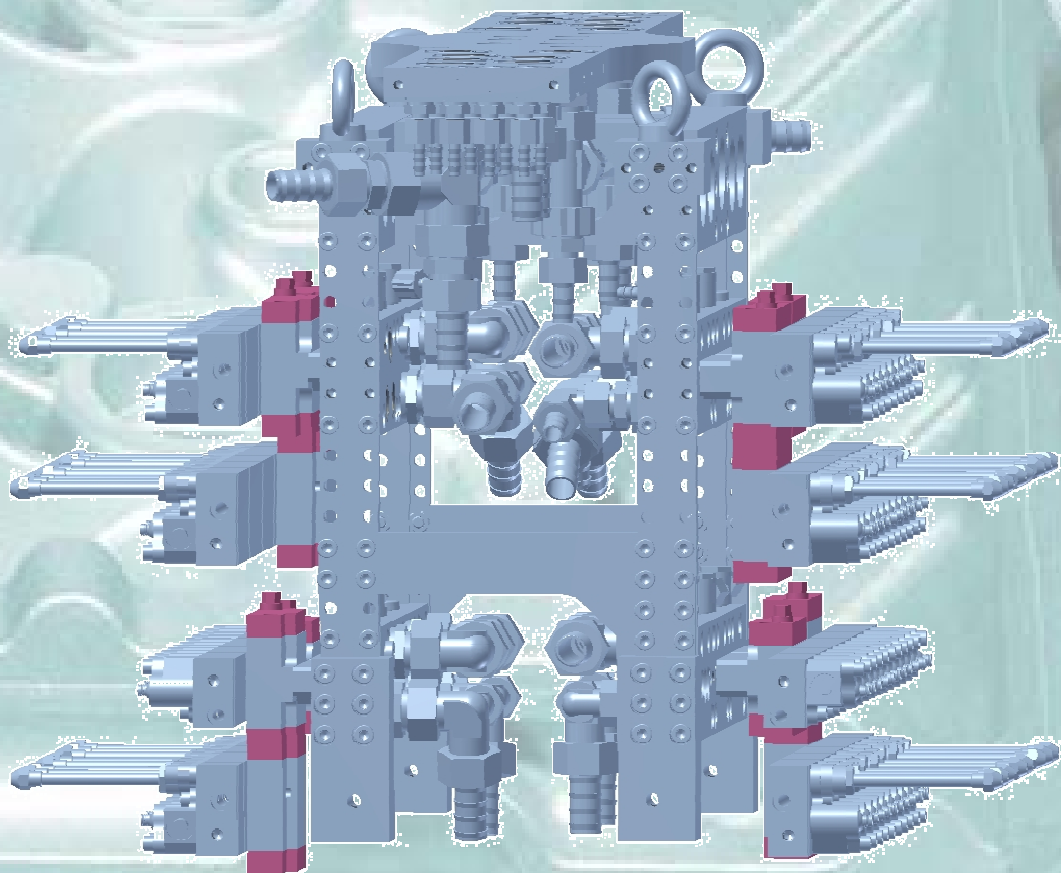



Artikelgruppe 11 Zubehör
 prod.group 11 addons

<p>011.1 Artikelnr./ partno.801235</p> <p>Adaptermodul 50mm PS16CXL, komplett Adaptor module 50mm PS16CXL, complete</p>		
<p>011.2 Artikelnr./ partno.801251</p> <p>Adaptermodul 30mm PS16CXL, komplett Adaptor module 30mm PS16CXL, complete</p>		
<p>011.3 Artikelnr./ partno.801327</p> <p>Adaptermodul 20mm PS16CXL, komplett Adaptor module 20mm PS16CXL, complete</p>		
<p>011.4 Artikelnr./ partno.801430</p> <p>Adaptermodul 55mm, 90° gedreht PS16CXL, komplett Adaptor module 55mm, 90° turned PS16CXL, complete</p>		
<p>011.5 Artikelnr./ partno.801451</p> <p>Adaptermodul 25mm PS16CXL, komplett Adaptor module 25mm PS16CXL, complete</p>		











Artikelgruppe 20 Zubehör prod.group 20 addons





Artikelgruppe 20 Zubehör
 prod.group 20 addons

020.1 Artikelnr./ partno.801249		
Verteilerumlenkung (vier Anschlüsse) PS16CXL, komplett Distributor deflection (four outlets) PS16CXL, complete		
020.2 Artikelnr./ partno.801263		
Verteilerdistanzmodul 20mm PS16CXL, komplett Distribution distance module 20mm PS16CXL, complete		
020.3 Artikelnr./ partno.801265		
Verteilerdistanzmodul 25mm PS16CXL, komplett Distribution strip spacer modul 25mm PS16CXL, complete		
020.4 Artikelnr./ partno.801267		
Verteilerdistanzmodul 30mm PS16CXL, komplett Distribution strip spacer modul 30mm PS16CXL, complete		
020.5 Artikelnr./ partno.801269		
Verteilerdistanzmodul 60mm PS16CXL, komplett Distribution distance module 60mm PS16CXL, complete		

Artikelgruppe 20 Zubehör
 prod.group 20 addons

020.6 Artikelnr./ partno.801271		
Verteilerdistanzmodul invers o.O-R PS16CXL, komplett Distribution strip inverse modul PS16CXL, complete, without O-rings		
020.7 Artikelnr./ partno.801273		
Verteilerumlenkung 45° HU PS16CXL, komplett, hinten/unten sprühend Distributor deflection 45° HU PS16CXL, complete, spraying rear/down		
020.8 Artikelnr./ partno.801276		
Verteilerschließplatte U PS16CXL, komplett Distribution cover down PS16CXL, complete		
020.9 Artikelnr./ partno.801321		
Verteilerdistanzmodul invers m.O-R PS16CXL, komplett Distribution strip inverse modul PS16CXL, complete, with O-ring		
020.10 Artikelnr./ partno.801323		
Verteilerschließplatte O PS16CXL, komplett, mit Entlüftung Distributor cover above PS16CXL, complete		





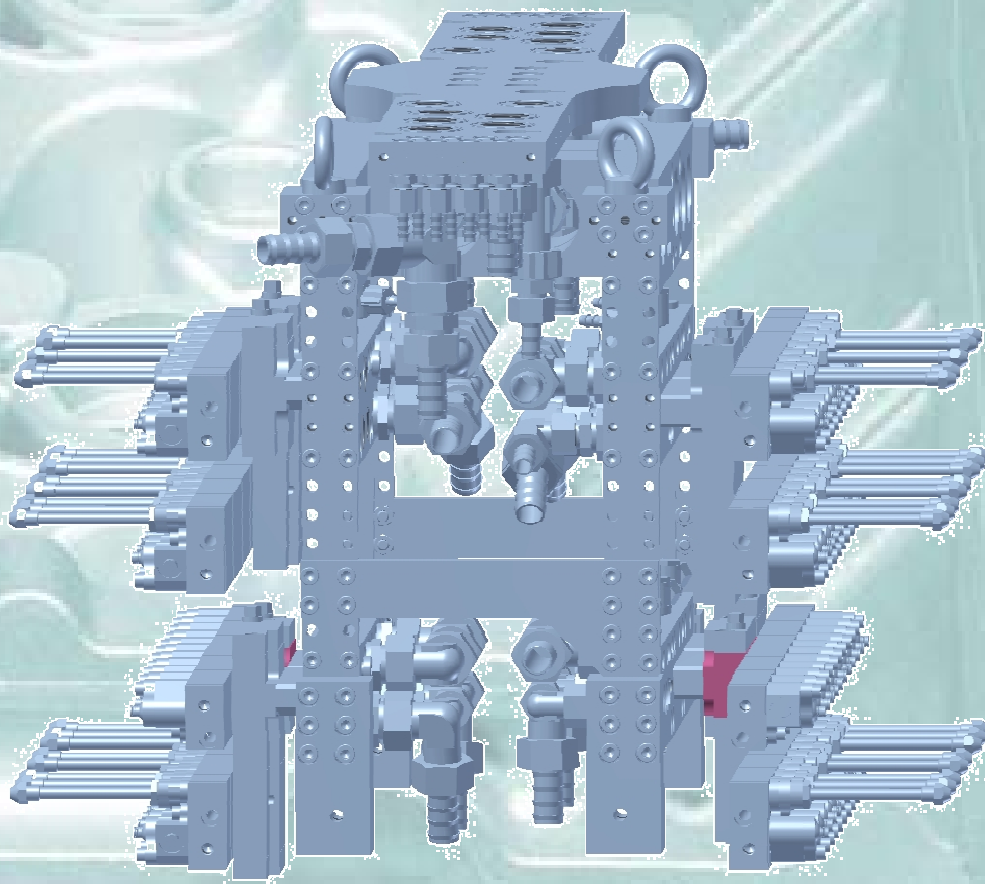

Artikelgruppe 020 Zubehör
prod.group 020 addons

020.11 Artikelnr./ partno.801466		
Verteilerdistanzmodul 15mm PS16CXL, komplett Distribution distance module 15mm PS16CXL, complete		

Artikelgruppe 22 Zubehör prod.group 22 addons



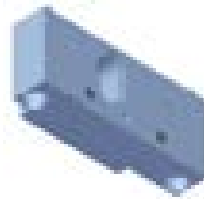





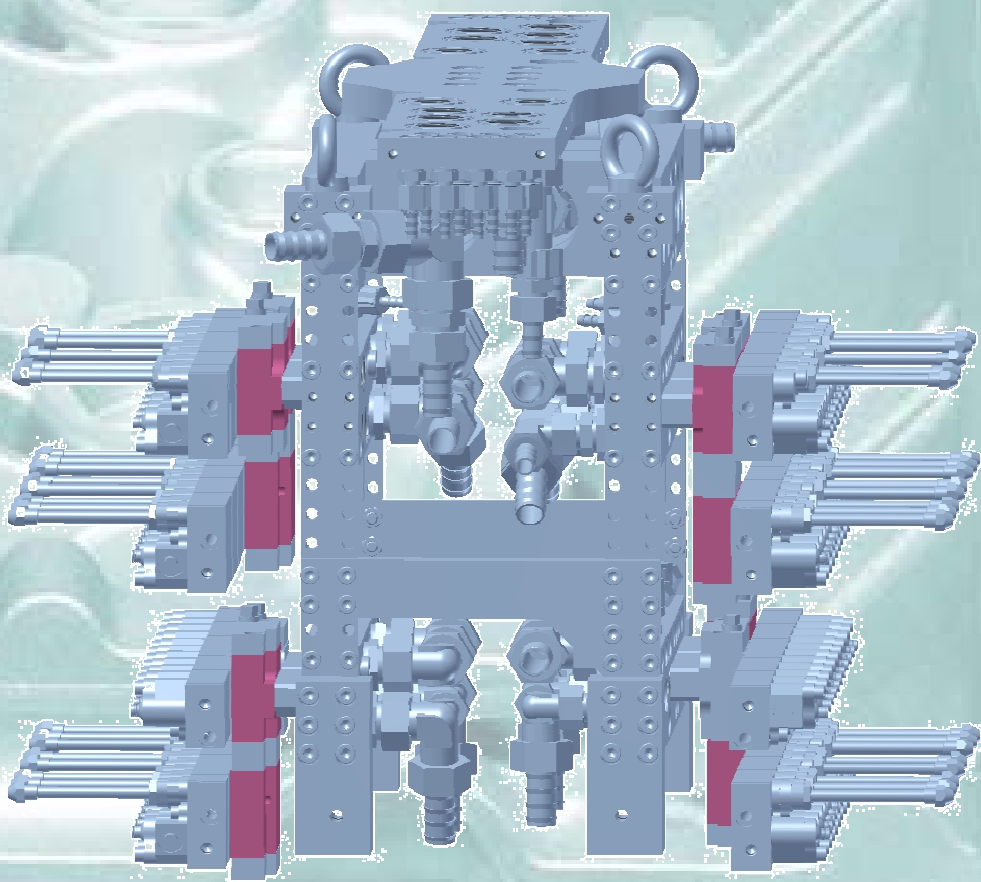

Artikelgruppe 22 Zubehör
 prod.group 22 addons

022.1 Artikelnr./ partno.801241		
Verteilerleiste (kompakt) PS16CXL, komplett Distribution strip (compact) PS16CXL, complete		
022.2 Artikelnr./ partno.801243		
Verteilerleistenmodul (kompakt) PS16CXL, komplett Distribution strip module (compact) PS16CXL, complete		
022.3 Artikelnr./ partno.801309		
Verteilerleistenmodul (kompakt) mit Anschluss PS16CXL, komplett, oben/unten geschlossen Distribution strip mod. (compact) w. connection PS16CXL, compl., closed on bottom and top		
022.4 Artikelnr./ partno.801325		
Verteileranschlussleiste (kompakt) PS16CXL, komplett Distribution connection strip (compact) PS16CXL, complete		

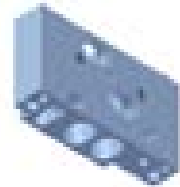



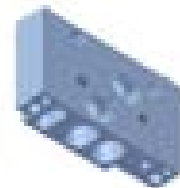

Artikelgruppe 23 Zubehör prod.group 23 addons



Artikelgruppe 23 Zubehör
 prod.group 23 addons

023.1 Artikelnr./ partno.801237		
Verteilerleiste (combi) PS16CXL, komplett Distribution strip (combi) PS16CXL, complete		
023.2 Artikelnr./ partno.801239		
Verteilerleistenmodul (combi) PS16CXL, komplett Distribution strip module (combi) PS16CXL, complete		
023.3 Artikelnr./ partno.801253		
Verteileranschlussleiste (combi) PS16CXL, komplett Distribution connection strip (combi) PS16CXL, complete		
023.4 Artikelnr./ partno.801311		
Verteilerleistenmodul (combi) PS16CXL, komplett, 180° gedreht Distribution strip module (combi) PS16CXL, complete, 180° twisted		
023.5 Artikelnr./ partno.801472		
Verteilerleistenmodul (combi) PS16CXL, komplett, oben geschlossen Distribution strip module (combi) PS16CXL, complete		



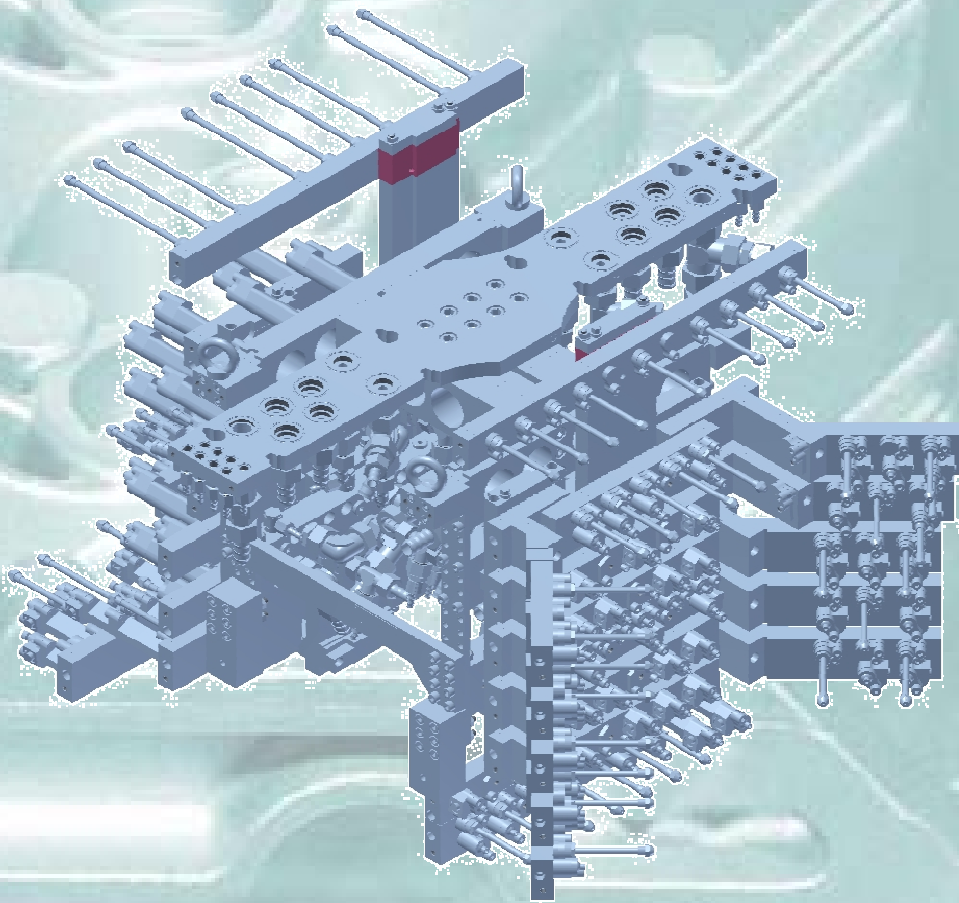

Artikelgruppe 23 Zubehör
 prod.group 23 addons

023.6 Artikelnr./ partno.801474		
Verteilerleiste (kombi) PS16CXL, komplett, unten geschlossen Distribution strip (combi) PS16CXL, complete, closed on the bottom		
023.7 Artikelnr./ partno.801485		
Verteilerleistenmodul (kombi) PS16CXL, komplett, unten geschlossen Distribution strip module (combi) PS16CXL, complete, closed on the bottom		
023.8 Artikelnr./ partno.801487		
Verteilerleistenmodul (kombi) PS16CXL, komplett, 180° gedreht, oben geschlossen Distribution strip module (combi) PS16CXL, complete, 180° twisted		

Artikelgruppe 25 Zubehör prod.group 25 addons





Artikelgruppe 25 Zubehör
prod.group 25 addons

025.1 Artikelnr./ partno.801317		
Verteilerleistenmodul (kompakt blasen) PS16CXL, komplett Distribution strip module (compact blasting) PS16CXL, complete		
025.2 Artikelnr./ partno.801497		
Verteilerleiste (kompakt blasen) PS16CXL, komplett Distribution strip module (compact blasting) PS16CXL, complete		

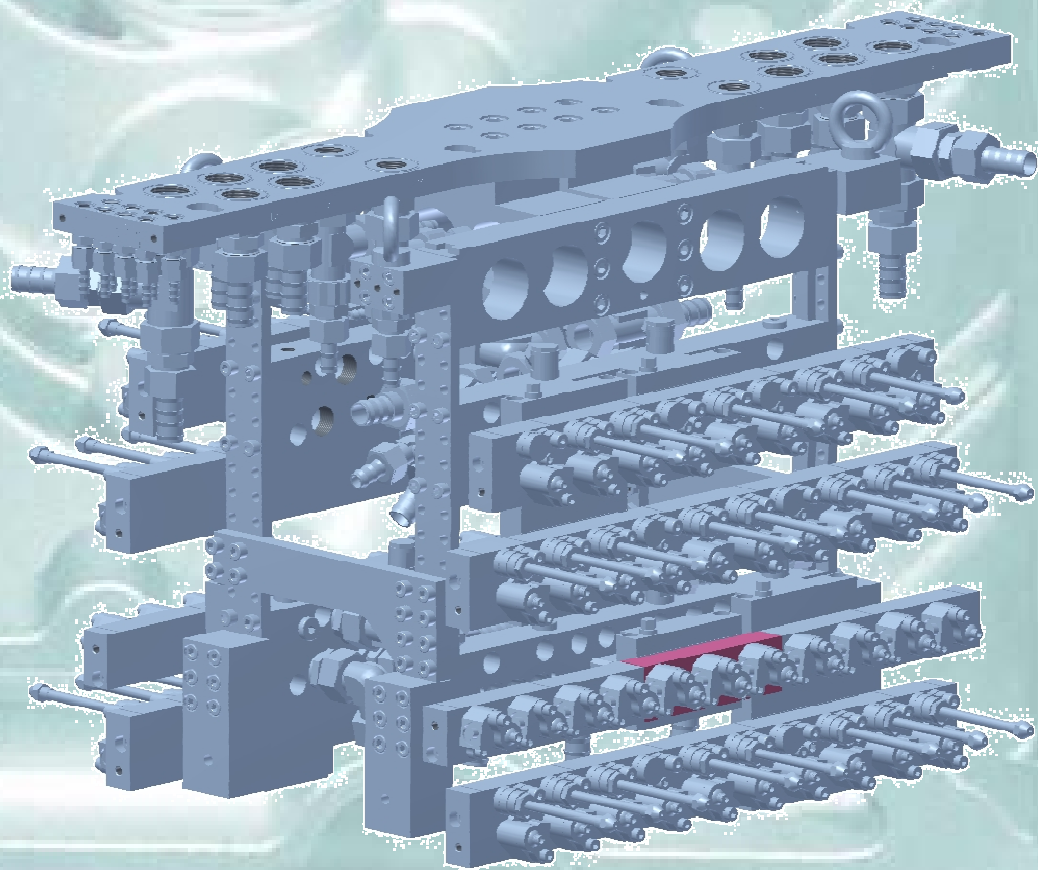
Artikelgruppe 31 Zubehör prod.group 31 addons



Artikelgruppe 31 Zubehör
prod.group 31 addons





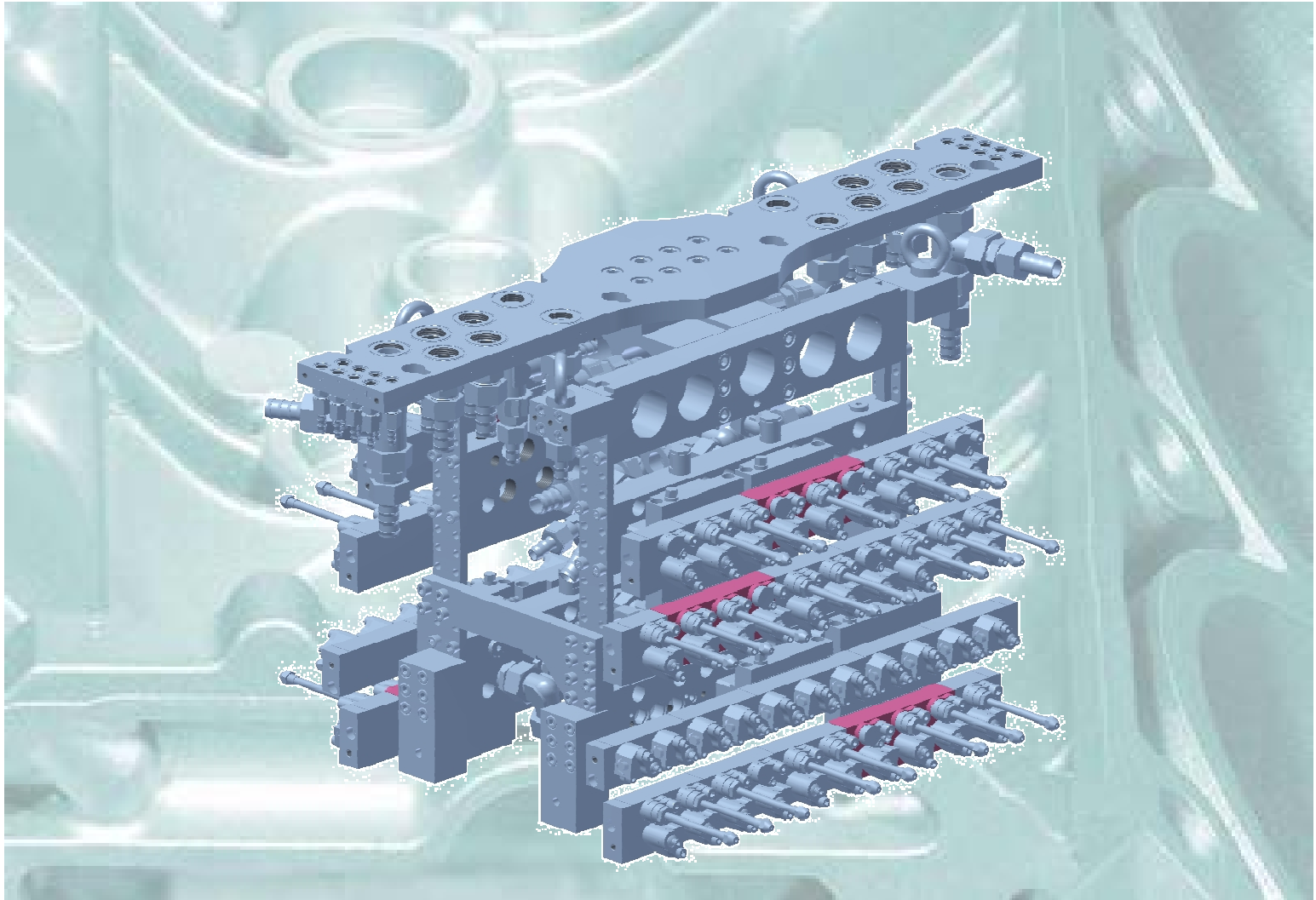



031.1 Artikelnr./ partno.801247		
Kompaktsprühleiste 150mm PS16CXL, komplett Compact spray strip 150mm PS16CXL, complete		

Artikelgruppe 32 Zubehör prod.group 32 addons



SPRÜHTECHNIK – PRODUKTKATALOG PS16CXL
 SPRAY TECHNOLOGY – PRODUCT CATALOG PS16CXL

Artikelgruppe 32 Zubehör
 prod.group 32 addons

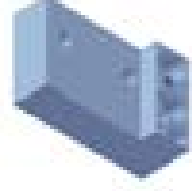
<p>032.1 Artikelnr./ partno.801245</p> <p>Kombisprühleiste 150mm PS16CXL, komplett</p> <p>Combi spray strip 150mm PS16CXL, complete</p>		
<p>032.2 Artikelnr./ partno.801257</p> <p>Kombianschlussleiste 100mm PS16CXL, komplett, links geschlossen</p> <p>Combi connection strip 100mm PS16CXL, complete, left closed</p>		
<p>032.3 Artikelnr./ partno.801261</p> <p>Kombianschlussleiste 100mm PS16CXL, komplett, rechts geschlossen</p> <p>Combi connection strip 100mm PS16CXL, complete, right closed</p>		
<p>032.4 Artikelnr./ partno.801313</p> <p>Kombisprühleiste 150mm PS16CXL, komplett, 180° gedreht</p> <p>Combi spray strip 150mm PS16CXL, complete, 180° twisted</p>		
<p>032.5 Artikelnr./ partno.801347</p> <p>Kombianschlussleiste 100mm mit 90° Winkel PS16CXL, komplett, rechts (links geschlossen)</p> <p>Combi connection strip 100mm with 90°angel PS16CXL, complete, right (left closed)</p>		



Artikelgruppe 032 Zubehör
prod.group 032 addons

032.6 Artikelnr./ partno.801349		
Kombianschlussleiste 100mm mit 90° Winkel PS16CXL, komplett, links (rechts geschlossen) Combi connection strip 100mm with 90° angle PS16CXL, complete, left (right closed)		

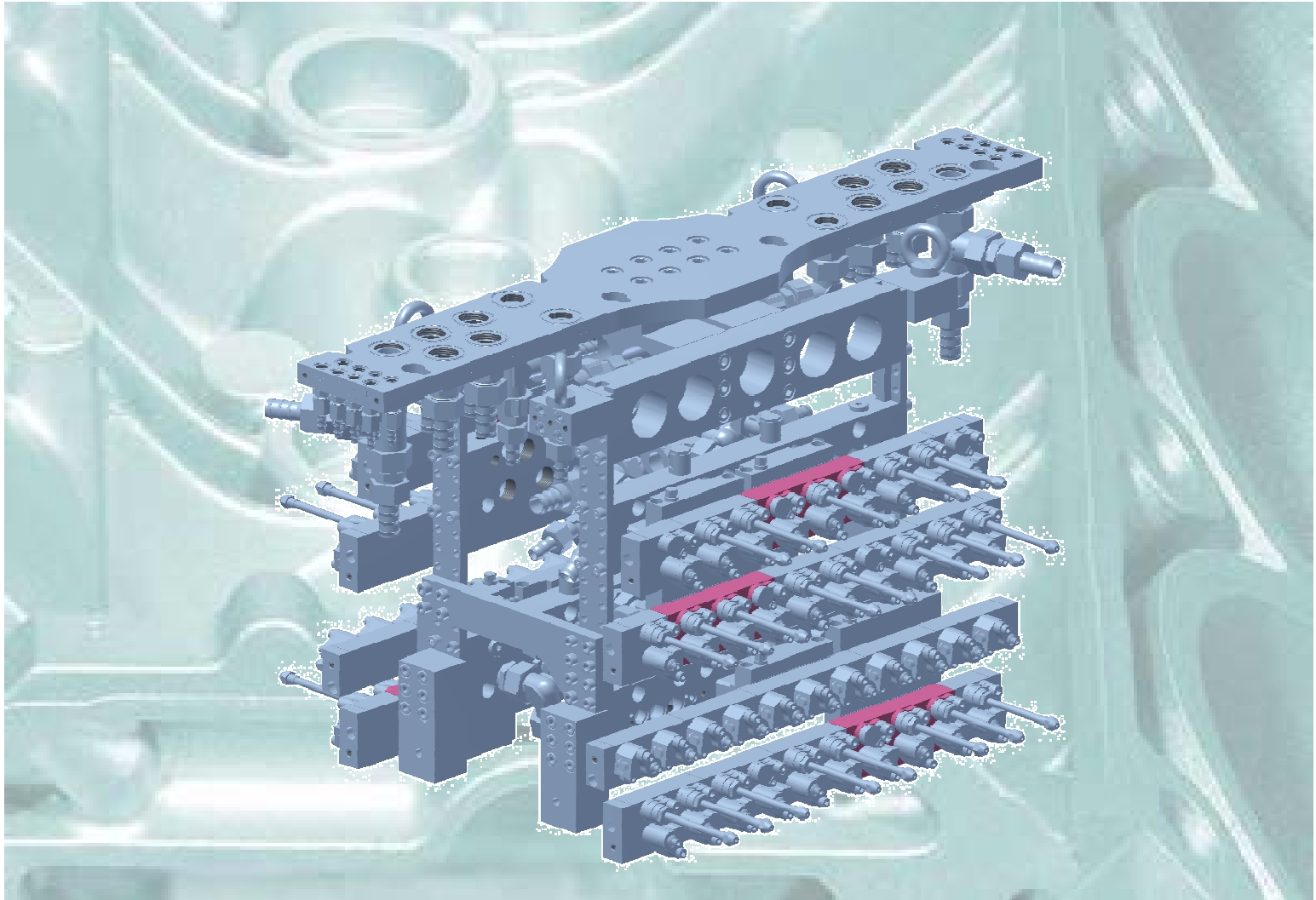
Artikelgruppe 34 Zubehör prod.group 34 addons









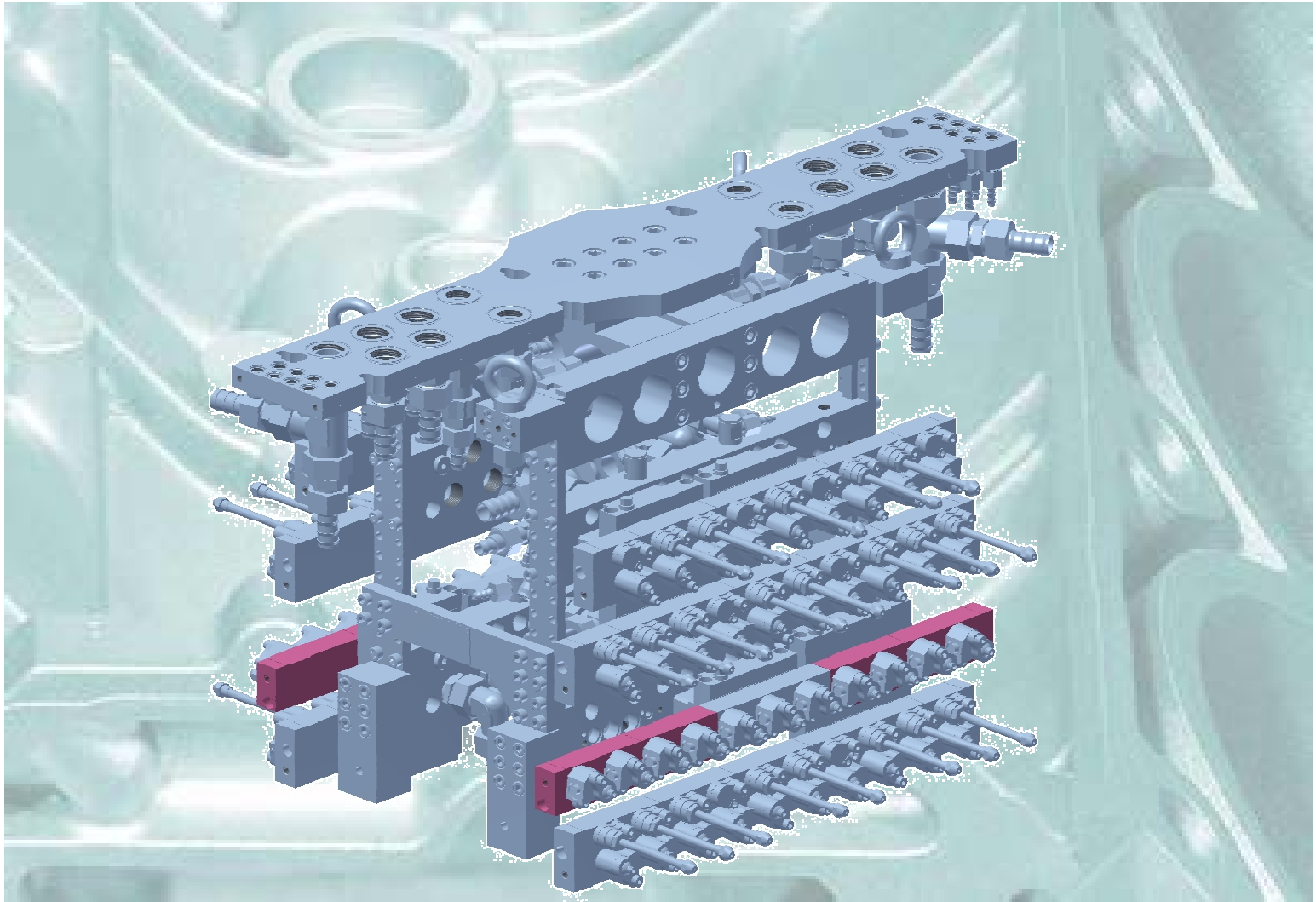



Artikelgruppe 34 Zubehör
prod.group 34 addons

034.1 Artikelnr./ partno.801319		
Blasleiste 150mm PS16CXL, komplett Blasting strip 150mm PS16CXL, complete		











Artikelgruppe 41 Zubehör prod.group 41 addons













Artikelgruppe 41 Zubehör
 prod.group 41 addons

041.1 Artikelnr./ partno.800062		
Kompaktsprühleistenmodul 100mm PS16C, komplett Compact spray strip module 100mm PS16C, complete		
041.2 Artikelnr./ partno.800076		
Kompaktsprühleistenschliessleiste R PS16C, komplett, mit O-Ringen Cover for compact spray strip R PS16C, complete, with o-rings		
041.3 Artikelnr./ partno.800077		
Kompaktsprühleistenschliessleiste L PS16C, komplett, ohne O-Ringe Cover for compact spray strip L PS16C, complete, without o-rings		
041.4 Artikelnr./ partno.800081		
Kompaktsprühleistenmodul 50mm PS16C, komplett Compact spray strip module 50mm PS16C, complete		
041.5 Artikelnr./ partno.800092		
Kompaktsprühleistenkreuzung PS16C, komplett Compact spray strip junction PS16C, complete		

Artikelgruppe 41 Zubehör
 prod.group 41 addons









<p>041.6 Artikelnr./ partno.800116</p>		
<p>Kompaktsprühleistenwinkel 1 PS16C, komplett Angle 1 for compact spray strips PS16C, complete</p>		
<p>041.7 Artikelnr./ partno.800118</p>		
<p>Kompaktsprühleistenwinkel 2 PS16C, komplett Angle 2 for compact spray strips PS16C, complete</p>		
<p>041.8 Artikelnr./ partno.800120</p>		
<p>Kompaktsprühleistenwinkel 3 PS16C, komplett Angle 3 for compact spray strips PS16C, complete</p>		
<p>041.9 Artikelnr./ partno.800122</p>		
<p>Kompaktsprühleistenwinkel 4 PS16C, komplett Angle 4 for compact spray strips PS16C, complete</p>		
<p>041.10 Artikelnr./ partno.800141</p>		
<p>Kompaktsprühleistendistanzmodul 100mm PS16C, komplett Compact spray strip spacer modul 100mm PS16C, complete</p>		

Artikelgruppe 41 Zubehör
 prod.group 41 addons



041.11 Artikelnr./ partno.800143		
Kompaktsprühleistendistanzmodul 50mm PS16C, komplett Compact spray strip spacer modul 50mm PS16C, complete		
041.12 Artikelnr./ partno.800326		
Kompaktsprühleistenwinkelstück 45°LHA PS16C, komplett, links hinten außensprühend Compact spray strip angled piece 45°LHA PS16C, complete, spraying left, rear, outside		
041.13 Artikelnr./ partno.800328		
Kompaktsprühleistenwinkelstück 45°LVI PS16C, komplett, links vorne innensprühend Compact spray strip angled piece 45°LVI PS16C, complete, spraying left, front, inside		
041.14 Artikelnr./ partno.800330		
Kompaktsprühleistenwinkelstück 45°RHA PS16C, komplett, rechts hinten außensprühend Compact spray strip angled piece 45°RHA PS16C, complete, spraying right, rear, outside		
041.15 Artikelnr./ partno.800332		
Kompaktsprühleistenwinkelstück 45°RVI PS16C, komplett, rechts vorne innensprühend Compact spray strip angled piece 45°RVI PS16C, complete, spraying right, front, inside		

SPRÜHTECHNIK – PRODUKTKATALOG PS16CXL
SPRAY TECHNOLOGY – PRODUCT CATALOG PS16CXL

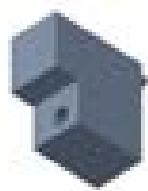
Artikelgruppe 41 Zubehör
prod.group 41 addons

041.16 Artikelnr./ partno.800354		
Kompaktsprühleistendistanzmodul 10mm PS16C, komplett Compact spray strip spacer module 10mm PS16C, complete		
041.17 Artikelnr./ partno.800369		
Kompaktsprühleisten-Inversmodul o.O-R PS16C, komplett Compact spray strip inverse module PS16C, complete, without o-rings		
041.18 Artikelnr./ partno.800371		
Kompaktsprühleisten-Inversmodul m.O-R PS16C, komplett Compact spray strip inverse module PS16C, complete, with o-rings		
041.19 Artikelnr./ partno.801617		
Kompaktsprühleistendistanzmodul 15mm PS16C, komplett Compact spray strip spacer module 10mm PS16C, complete		
041.20 Artikelnr./ partno.801737		
Kompaktsprühabschlußleiste 50mm rechts PS16C, komplett Right end compact spray strip module 50mm PS16C, complete		







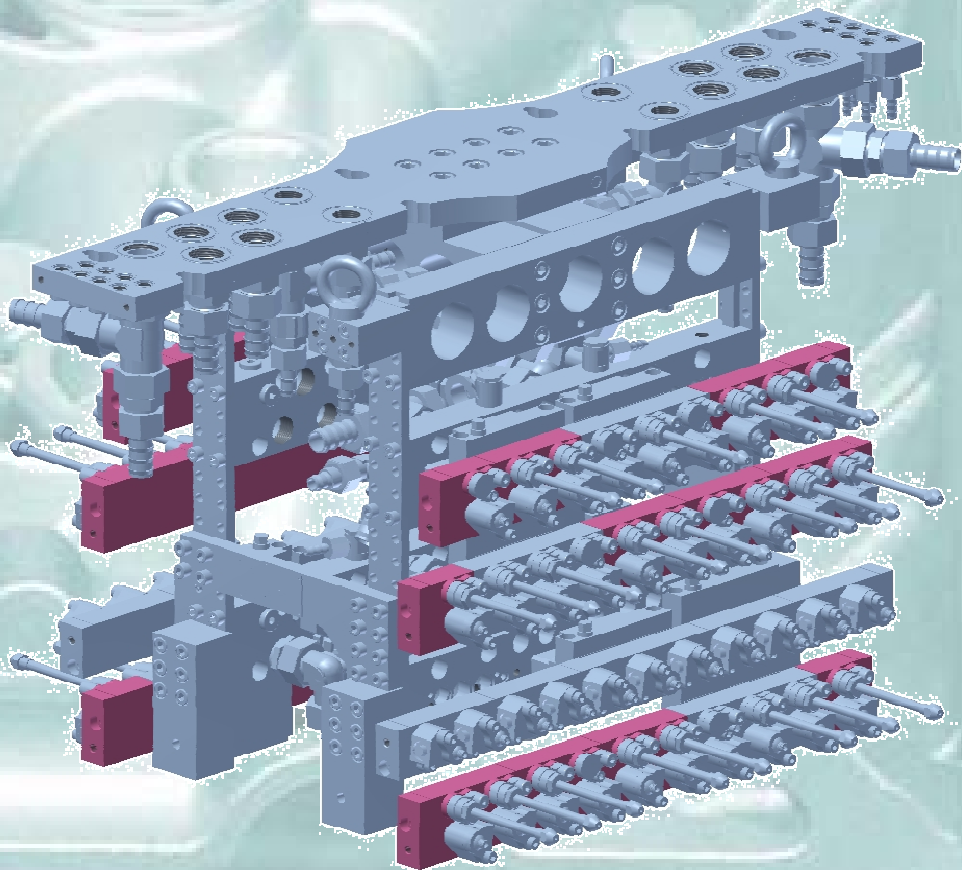

Artikelgruppe 041 Zubehör
prod.group 041 addons

041.21 Artikelnr./ partno.801744		
Kompaktsprühabschlußleiste 50mm links PS16C, komplett Left end compact spray strip module 50mm PS16C, complete		

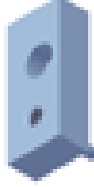

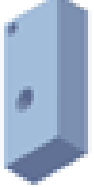







Artikelgruppe 42 Zubehör prod.group 42 addons







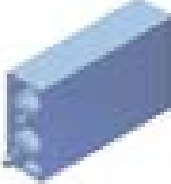





Artikelgruppe 42 Zubehör
 prod.group 42 addons

042.1 Artikelnr./ partno.800066		
Kombisprühleistenmodul 100mm PS16C, komplett Combi spray strip module 100mm PS16C, complete		
042.2 Artikelnr./ partno.800073		
Kombisprühleistenschliessleiste R PS16C, komplett, mit O-Ringen Cover for combi spray strip R PS16C, complete, with o-rings		
042.3 Artikelnr./ partno.800074		
Kombisprühleistenschliessleiste L PS16C, komplett, ohne O-Ringe Cover for combi spray strip L PS16C, complete, without o-rings		
042.4 Artikelnr./ partno.800085		
Kombisprühleistenmodul 50mm PS16C, komplett Combi spray strip module 50mm PS16C, complete		
042.5 Artikelnr./ partno.800096		
Kombisprühleistenkreuzung PS16C, komplett Combi spray strip junction PS16C, complete		











Artikelgruppe 42 Zubehör
 prod.group 42 addons

042.6 Artikelnr./ partno.800108		
Kombisprühleistenwinkel 1 PS16C, komplett Angle 1 for combi spray strips PS16C, complete		
042.7 Artikelnr./ partno.800110		
Kombisprühleistenwinkel 2 PS16C, komplett Angle 2 for combi spray strips PS16C, complete		
042.8 Artikelnr./ partno.800112		
Kombisprühleistenwinkel 3 PS16C, komplett Angle 3 for combi spray strips PS16C, complete		
042.9 Artikelnr./ partno.800114		
Kombisprühleistenwinkel 4 PS16C, komplett Angle 4 for combi spray strips PS16C, complete		
042.10 Artikelnr./ partno.800145		
Kombisprühleistendistanzmodul 100mm PS16C, komplett Combi spray strip spacer module 100mm PS16C, complete		



Artikelgruppe 42 Zubehör
 prod.group 42 addons

042.11 Artikelnr./ partno.800147		
<p>Kombisprühleistendistanzmodul 50mm PS16C, komplett Combi spray strip spacer module 50mm PS16C, complete</p>		
042.12 Artikelnr./ partno.800318		
<p>Kombisprühleistenwinkelstück 45°LHA PS16C, komplett, links hinten außensprühend Combi spray strip angled piece 45°LHA PS16C, complete, spraying left, rear, outside</p>		
042.13 Artikelnr./ partno.800320		
<p>Kombisprühleistenwinkelstück 45°LVI PS16C, komplett, links vorne innensprühend Combi spray strip angled piece 45°LVI PS16C, complete, spraying left, front, inside</p>		
042.14 Artikelnr./ partno.800322		
<p>Kombisprühleistenwinkelstück 45°RHA PS16C, komplett, rechts hinten außensprühend Combi spray strip angled piece 45°RHA PS16C, complete, spraying right, rear, outside</p>		
042.15 Artikelnr./ partno.800324		
<p>Kombisprühleistenwinkelstück 45°RVI PS16C, komplett, rechts vorne innensprühend Combi spray strip angled piece 45°RVI PS16C, complete, spraying right, front, inside</p>		

Artikelgruppe 42 Zubehör
 prod.group 42 addons

042.16 Artikelnr./ partno.800358		
Kombisprühleistendistanzmodul 10mm PS16C, komplett Combi spray strip spacer module 10mm PS16C, complete		
042.17 Artikelnr./ partno.800373		
Kombisprühleisten-Inversmodul o.O-R PS16C, komplett Combi spray strip inverse module PS16C, complete, without o-rings		
042.18 Artikelnr./ partno.800375		
Kombisprühleisten-Inversmodul m.O-R PS16C, komplett Combi spray strip inverse module PS16C, complete, with o-rings		
042.19 Artikelnr./ partno.801438		
Kombisprühabschlußleiste 50mm rechts PS16C, komplett Right end combispray strip module 50mm PS16C, complete		
042.20 Artikelnr./ partno.801440		
Kombisprühabschlußleiste 50mm links PS16C, komplett Left end combispray strip module 50mm PS16C, complete		







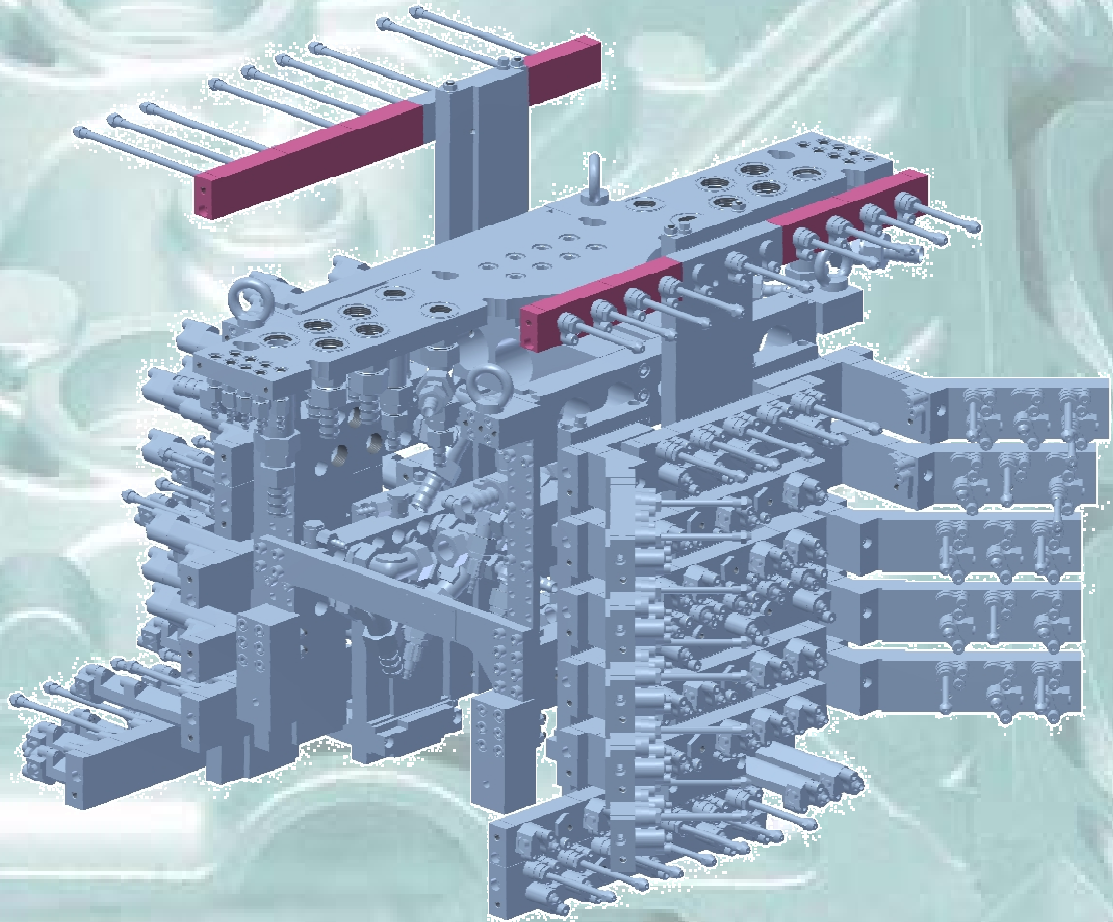



Artikelgruppe 042 Zubehör
prod.group 042 addons

042.21 Artikelnr./ partno.801792		
Kombisprühleistenmodul 50mm PS16C, komplett, beidseitig Combi spray strip module 50mm PS16C, complete		











Artikelgruppe 44 Zubehör prod.group 44 addons













Artikelgruppe 44 Zubehör
 prod.group 44 addons

044.1 Artikelnr./ partno.800064		
Blasleistenmodul 100mm PS16C, komplett Blasting strip module 100mm PS16C, complete		
044.2 Artikelnr./ partno.800083		
Blasleistenmodul 50mm PS16C, komplett Blasting strip module 50mm PS16C, complete		
044.3 Artikelnr./ partno.800089		
Blasleistenschliessleiste R (kompakt) PS16C, komplett Cover for compact blasting strip R PS16C, complete, with o-rings		
044.4 Artikelnr./ partno.800090		
Blasleistenschliessleiste L (kompakt) PS16C, komplett Cover for compact blasting strip L PS16C, complete, without o-rings		
044.5 Artikelnr./ partno.800094		
Blasleistenkreuzung PS16C, komplett Blasting strip junction PS16C, complete		







Artikelgruppe 44 Zubehör
 prod.group 44 addons

044.6 Artikelnr./ partno.800124		
Blasleistenwinkel 1 PS16C, komplett Angle 1 for blast strip 45		
044.7 Artikelnr./ partno.800126		
Blasleistenwinkel 2 PS16C, komplett angle 2 for blasting strip 45		
044.8 Artikelnr./ partno.800128		
Blasleistenwinkel 3 PS16C, komplett Angle 3 for blast strip 45		
044.9 Artikelnr./ partno.800130		
Blasleistenwinkel 4 PS16C, komplett Angle 4 for blast strip 45		
044.10 Artikelnr./ partno.800153		
Blasleistendistanzmodul 100mm PS16C, komplett Blasting strip spacer module 100mm PS16C, complete		

Artikelgruppe 44 Zubehör
 prod.group 44 addons

<p>044.11 Artikelnr./ partno.800155</p>		
<p>Blasleistendistanzmodul 50mm PS16C, komplett Blasting strip spacer module 50mm PS16C, complete</p>		
<p>044.12 Artikelnr./ partno.800302</p>		
<p>Blasleistenwinkelstück 45°LHA PS16C, komplett, links hinten außenblasend Blasting strip angled piece 45°LHA PS16C, complete, spraying left, rear, outside</p>		
<p>044.13 Artikelnr./ partno.800304</p>		
<p>Blasleistenwinkelstück 45°LVI PS16C, komplett, links vorne innenblasend Blasting strip angled piece 45°LVI PS16C, complete, spraying left, front, inside</p>		
<p>044.14 Artikelnr./ partno.800306</p>		
<p>Blasleistenwinkelstück 45°RHA PS16C, komplett, rechts hinten außenblasend Blasting strip angled piece 45°RHA PS16C, complete, spraying right, rear, outside</p>		
<p>044.15 Artikelnr./ partno.800308</p>		
<p>Blasleistenwinkelstück 45°RVI PS16C, komplett, rechts vorne innenblasend Blasting strip angled piece 45°RVI PS16C, complete, spraying right, front, inside</p>		







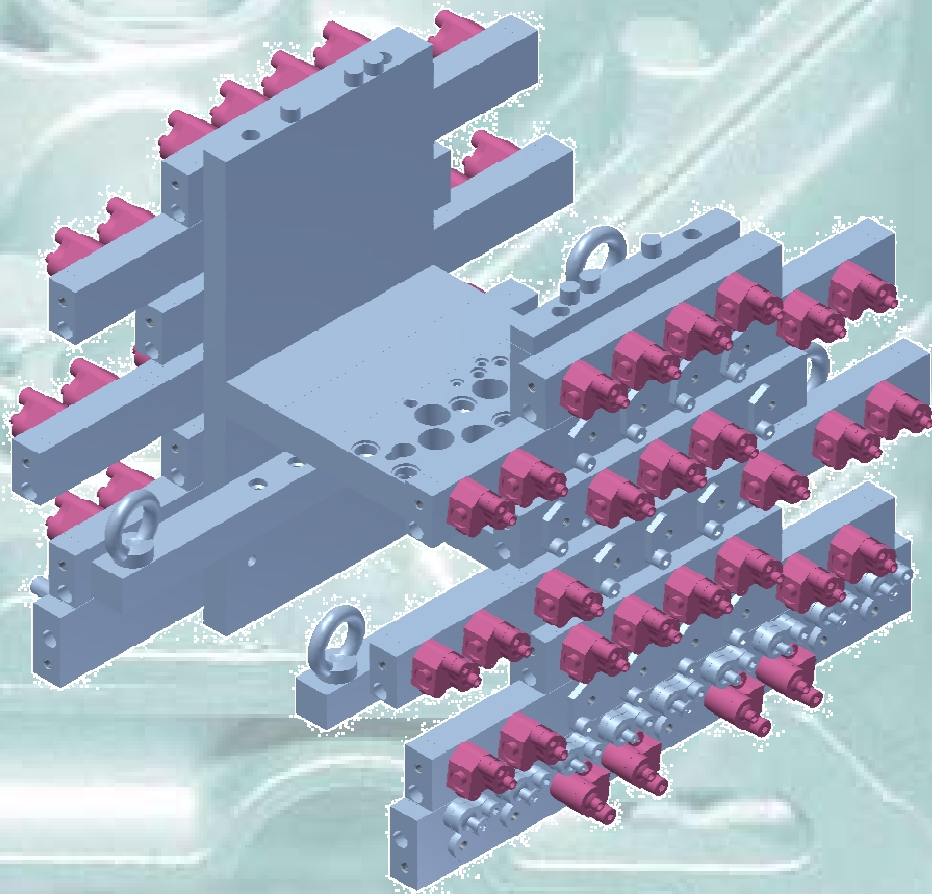



Artikelgruppe 44 Zubehör
 prod.group 44 addons

044.16 Artikelnr./ partno.800356		
Blasteistendistanzmodul 10mm PS16C, komplett Blasting strip spacer module 10mm PS16C, complete		
044.17 Artikelnr./ partno.800379		
Blasteisten-Inversmodul o.O-R PS16C, komplett Blasting strip inverse module PS16C, complete, without o-rings		
044.18 Artikelnr./ partno.800381		
Blasteisten-Inversmodul m.O-R PS16C, komplett Blasting strip inverse module PS16C, complete, with o-rings		











Artikelgruppe 50 Zubehör prod.group 50 addons



Artikelgruppe 50 Zubehör
 prod.group 50 addons

050.1 Artikelnr./ partno.800008		
Sprühdüse SD14 SD-A-04+KD-A-06 Spray nozzle SD14 SD-A-04+KD-A-06		
050.2 Artikelnr./ partno.800278		
Sprühdüse SD14 Basis SD-A-04 Spray nozzle SD14 carrier SD-A-04		
050.3 Artikelnr./ partno.800542		
Sprühdüse SD14 SD-A-04+KD-A-02 Spray nozzle SD-A-04+KD-A-02		
050.4 Artikelnr./ partno.800543		
Sprühdüse SD14 SD-A-04+KD-A-04 Spray nozzle SD-A-04+KD-A-04		
050.5 Artikelnr./ partno.800544		
Sprühdüse SD14 SD-A-04+KD-A-08 Spray nozzle SD-A-04+KD-A-08		

Artikelgruppe 50 Zubehör
 prod.group 50 addons

050.6 Artikelnr./ partno.800545		
Sprühdüse SD14 SD-A-04+KD-A-10 Spray nozzle SD-A-04+KD-A-10		
050.7 Artikelnr./ partno.800546		
Sprühdüse SD14 SD-A-04+KD-A-15 Spray nozzle SD-A-04+KD-A-15		
050.8 Artikelnr./ partno.800547		
Sprühdüse SD14 SD-A-04+KD-A-20 Spray nozzle SD-A-04+KD-A-20		
050.9 Artikelnr./ partno.800548		
Sprühdüse SD14 SD-A-04+KD-A-F Spray nozzle SD-A-04+KD-A-F		
050.10 Artikelnr./ partno.800549		
Sprühdüse SD14 SD-A-04+KD-A-B Spray nozzle SD-A-04+KD-A-B		

Artikelgruppe 70 Zubehör prod.group 70 addons

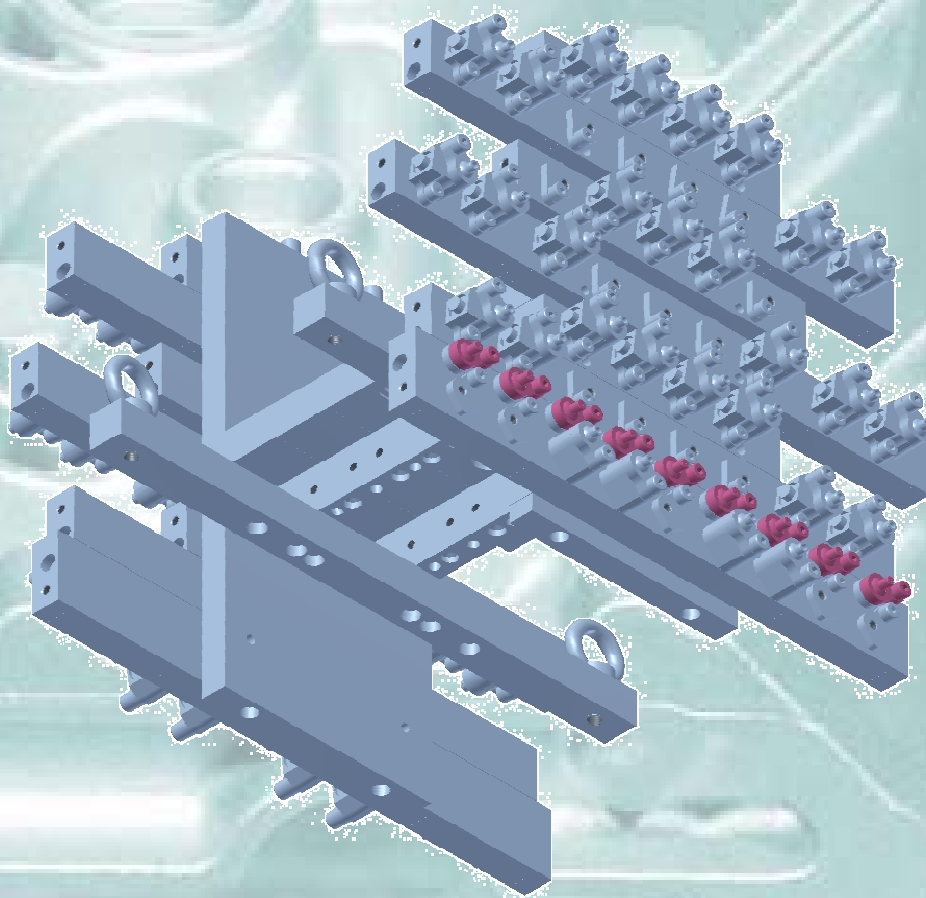







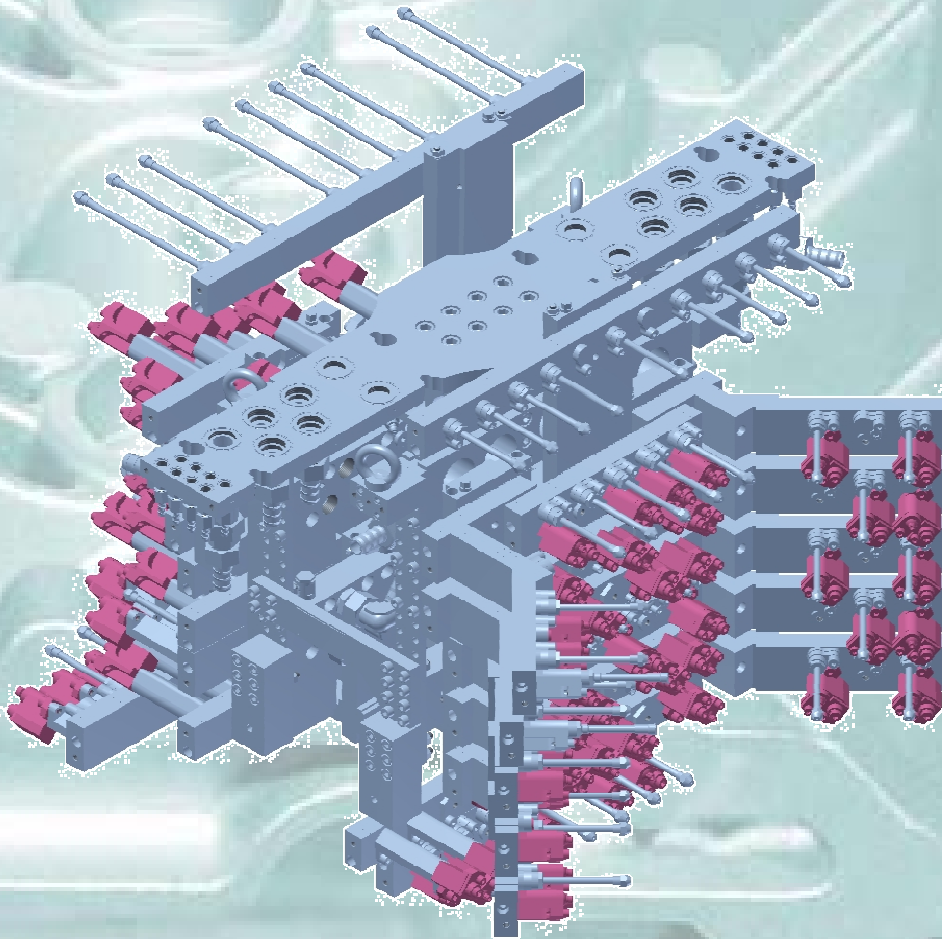

Artikelgruppe 70 Zubehör
 prod.group 70 addons

070.1 Artikelnr./ partno.800133		
<p>Blas-Set mit KD-I-26 ohne Einsatz, mit Schraube M8, gerundet Blasting set with KD-I-26 without insert, with screw M8, rounded</p>		
070.2 Artikelnr./ partno.801254		
<p>Blas-Set mit KD-I-30 ohne Einsatz, mit Schraube M8, gerundet Blasting set with KD-I-30 without insert, with screw M8, rounded</p>		
070.3 Artikelnr./ partno.801328		
<p>Blas-Set mit KD-I-26 (50mm lang) ohne Einsatz, mit Schraube M8, gerundet Blasting set with KD-I-26 (50mm) without insert, with screw M8, rounded</p>		
070.4 Artikelnr./ partno.801382		
<p>Blas-Set mit KD-I-20 ohne Einsatz, mit Schraube M8, gerundet Blasting set with KD-I-20 without insert, with screw M8, rounded</p>		











Artikelgruppe 80 Zubehör prod.group 80 addons













Artikelgruppe 80 Zubehör
 prod.group 80 addons

080.1 Artikelnr./ partno.800413		
Dosierdüse DD-A-4-76-V+KD-A-06 Dosing nozzle DD-A-4-76-V+KD-A-06		
080.2 Artikelnr./ partno.800593		
Dosierdüse Basis DD-A-4-76-V dosing nozzle carrier DD-A-4-76-V		
080.3 Artikelnr./ partno.800807		
Dosierdüse DD-A-3-43-V+KD-A-06 Dosing nozzle DD-A-3-43-V+KD-A-06		
080.4 Artikelnr./ partno.801120		
Dosierdüse Basis DD-A-3-43-V dosing nozzle carrier DD-A-3-43-V		
080.5 Artikelnr./ partno.801130		
Dosierdüse DD-A-5-119-V+KD-A-06 Dosing nozzle DD-A-5-119-V+KD-A-06		











Artikelgruppe 80 Zubehör
 prod.group 80 addons

080.6 Artikelnr./ partno.801149		
Dosierdüse Basis DD-A-5-119-V dosing nozzle carrier DD-A-5-119-V		
080.7 Artikelnr./ partno.801285		
Dosierdüse DDV-A-4-76-V+KD-A-06 Dosing nozzle DDV-A-4-76-V+KD-A-06		
080.8 Artikelnr./ partno.801329		
Dosierdüse DDV-A-3-43-V+KD-A-06 Dosing nozzle DDV-A-3-43-V+KD-A-06		
080.9 Artikelnr./ partno.801333		
Dosierdüse Basis DDV-A-4-76-V Dosing nozzle carrier DDV-A-4-76-V		
080.10 Artikelnr./ partno.801337		
Dosierdüse DDV-A-2-19-V+KD-A-06 Dosing nozzle DDV-A-2-19-V+KD-A-06		







Artikelgruppe 80 Zubehör
 prod.group 80 addons

080.11 Artikelnr./ partno.801338		
<p>Dosierdüse DDV-A-5-119-V+KD-A-06</p> <p>Dosing nozzle DDV-A-5-119-V+KD-A-06</p>		
080.12 Artikelnr./ partno.801511		
<p>Dosierdüse Basis DDV-A-3-43-V</p> <p>Dosing nozzle carrier DDV-A-3-43-V</p>		
080.13 Artikelnr./ partno.801588		
<p>Kappe mit Festanschlag 1 für Dosierdüse, komplett</p> <p>Cap with fixed stop 1 for dosing nozzle, complete</p>		
080.14 Artikelnr./ partno.801589		
<p>Kappe mit Festanschlag 2 für Dosierdüse, komplett</p> <p>Cap with fixed stop 2 for dosing nozzle, complete</p>		
080.15 Artikelnr./ partno.801590		
<p>Kappe mit Festanschlag 3 für Dosierdüse, komplett</p> <p>Cap with fixed stop 3 for dosing nozzle, complete</p>		

Artikelgruppe 80 Zubehör
 prod.group 80 addons

080.16 Artikelnr./ partno.801591		
<p>Kappe mit Festanschlag 4 für Dosierdüse, komplett</p> <p>Cap with fixed stop 4 for dosing nozzle, complete</p>		
080.17 Artikelnr./ partno.801592		
<p>Kappe mit Festanschlag 5 für Dosierdüse, komplett</p> <p>Cap with fixed stop 5 for dosing nozzle, complete</p>		
080.18 Artikelnr./ partno.801593		
<p>Kappe mit Festanschlag 6 für Dosierdüse, komplett</p> <p>Cap with fixed stop 6 for dosing nozzle, complete</p>		
080.19 Artikelnr./ partno.801622		
<p>Dosierdüse Basis DDV-A-5-119-V</p> <p>Dosing nozzle carrier DDV-A-5-119-V</p>		
080.20 Artikelnr./ partno.801681		
<p>Sprühdüse FSD FSD-A-10+KD-A-06</p> <p>Spray nozzle FSD FSD-A-10+KD-A-06</p>		







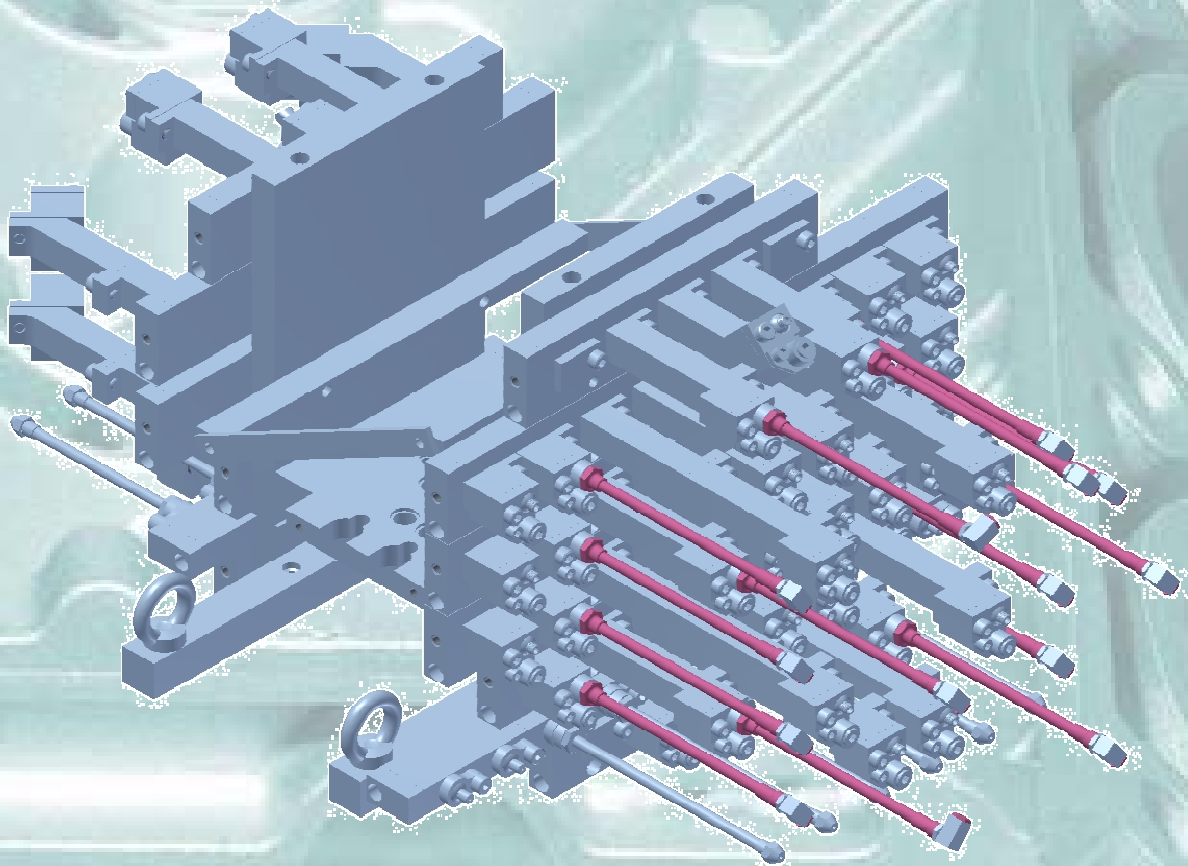



Artikelgruppe 80 Zubehör
 prod.group 80 addons

080.21 Artikelnr./ partno.801690		
Sprühdüse FSD FSD-A-10+KD-A-04 Spray nozzle FSD FSD-A-10+KD-A-04		
080.22 Artikelnr./ partno.801691		
Sprühdüse FSD Basis FSD-A-10 Spray nozzle FSD basis FSD-A-10		
080.23 Artikelnr./ partno.801782		
Sprühdüse FSD FSD-A-10+KD-A-F-03-FZ Spray nozzle FSD FSD-A-09+KD-A-F-03-FZ		











Artikelgruppe 90 Zubehör prod.group 90 addons





Artikelgruppe 90 Zubehör
 prod.group 90 addons

090.1 Artikelnr./ partno.177733		
Rohr R-A-100 Tube R-A-100		
090.2 Artikelnr./ partno.177741		
Rohr R-A-150 Tube R-A-150		
090.3 Artikelnr./ partno.177758		
Rohr R-A-200 Tube R-A-200		
090.4 Artikelnr./ partno.177766		
Rohr R-A-250 Tube R-A-250		
090.5 Artikelnr./ partno.177774		
Rohr R-A-300 Tube R-A-300		

Artikelgruppe 90 Zubehör
 prod.group 90 addons

090.6 Artikelnr./ partno.179077		
Rohrenddüse RD-A-10 Nozzle for tube RD-A-10		
090.7 Artikelnr./ partno.301522		
Rohrenddüse RD-A-04 Nozzle for tube RD-A-04		
090.8 Artikelnr./ partno.302118		
Rohrenddüse RD-A-B Nozzle for tube RD-A-B		
090.9 Artikelnr./ partno.306598		
Verschluss für Sprührohr AM RD-A-V blind plug RD-A-V		
090.10 Artikelnr./ partno.800282		
Umlenkung 90° für Rohrenddüse RD-A, komplett Direction change 90° for nozzle for tube RD-A, complete		







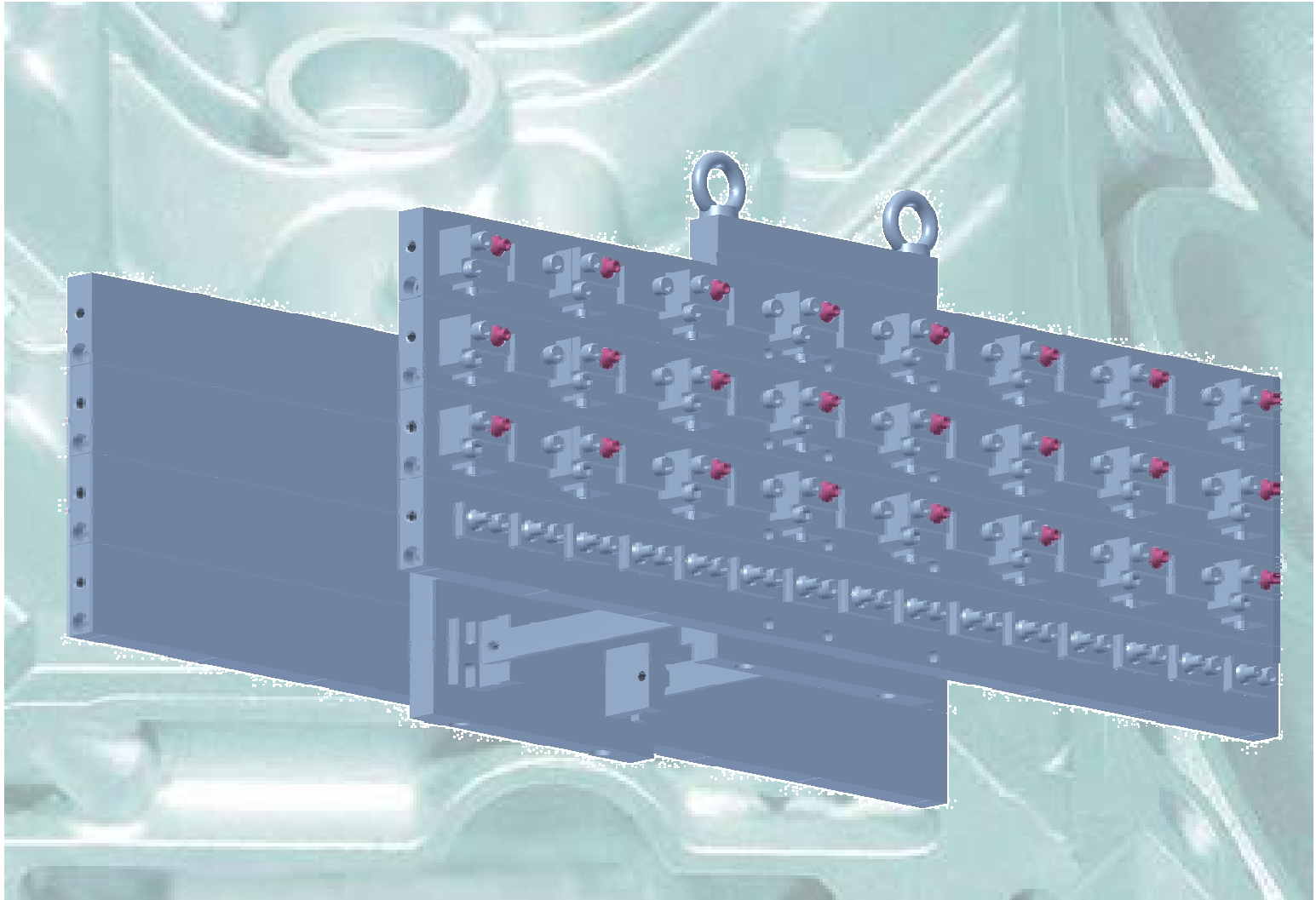



Artikelgruppe 90 Zubehör
prod.group 90 addons

090.11 Artikelnr./ partno.801055		
T-Umlenkung für Rohrenddüse RD-A, komplett T-direction change for nozzle for tube RD-A; complete		
090.12 Artikelnr./ partno.801058		
L-Umlenkung für Rohrenddüse RD-A, komplett L-direction change for nozzle for tube RD-A; complete		
090.13 Artikelnr./ partno.801060		
Rohrenddüse RD-A-06 Nozzle for tube RD-A-06		











Artikelgruppe 91 Zubehör prod.group 91 addons





Artikelgruppe 91 Zubehör
 prod.group 91 addons

091.1 Artikelnr./ partno.177709		
Kugeldüse KD-A-06 Ball nozzle KD-A-06		
091.2 Artikelnr./ partno.177717		
Kugeldüse KD-A-B-60° / Mittel 1xø0,4 / 6xø0,6 Ball nozzle KD-A-B-60° / fluid 1xø0,4 / 6xø0,6		
091.3 Artikelnr./ partno.177725		
Kugeldüse KD-A-F Ball nozzle KD-A-F		
091.4 Artikelnr./ partno.177824		
Kugeldüse KD-A-08 Ball nozzle KD-A-08		
091.5 Artikelnr./ partno.177832		
Kugeldüse KD-A-10 Ball nozzle KD-A-10		

Artikelgruppe 91 Zubehör
 prod.group 91 addons

091.6 Artikelnr./ partno.301933		
Kugeldüse KD-A-04 Ball nozzle KD-A-04		
091.7 Artikelnr./ partno.302383		
Kugeldüse KD-A-06-S (Verstellbereich 120°) Ball nozzle KD-A-06-S (adjusting range 120°)		
091.8 Artikelnr./ partno.304146		
Kugeldüse KD-A-15 Ball nozzle KD-A-15		
091.9 Artikelnr./ partno.304147		
Kugeldüse KD-A-20 Ball nozzle KD-A-20		
091.10 Artikelnr./ partno.800400		
Kugeldüse KD-A-02 Ball nozzle KD-A-02		







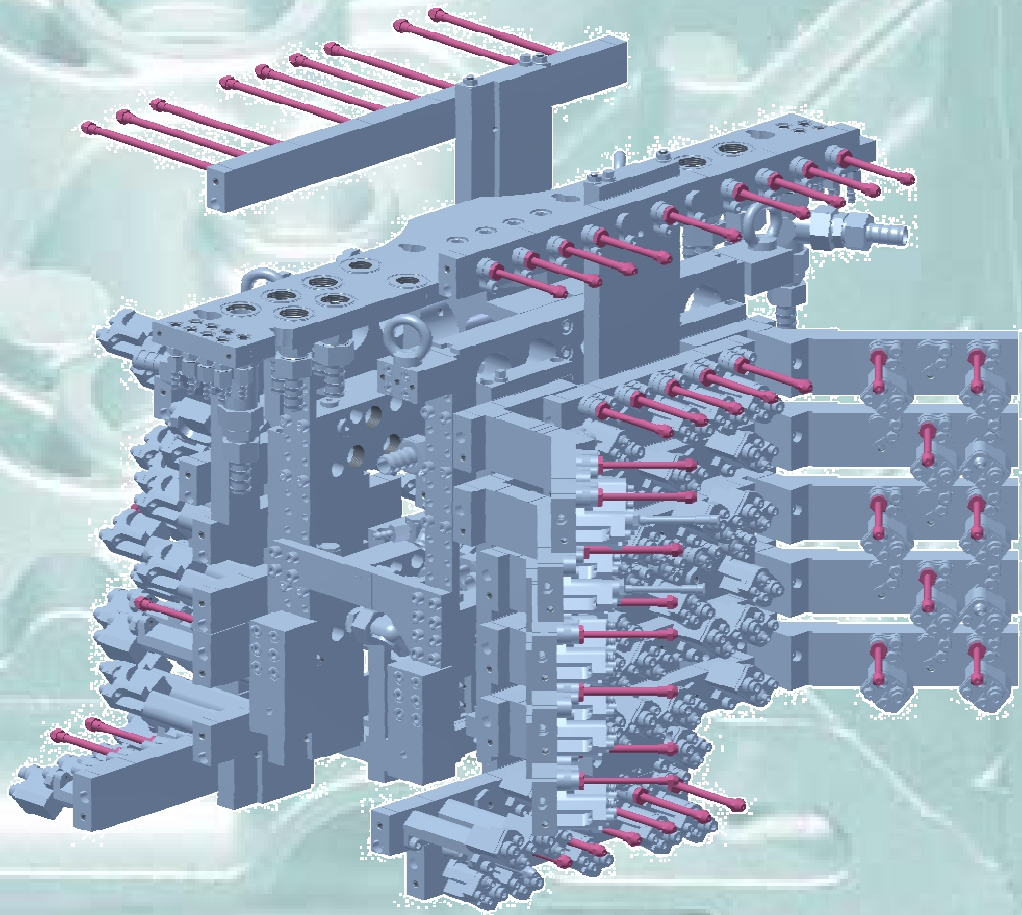

Artikelgruppe 091 Zubehör
prod.group 091 addons

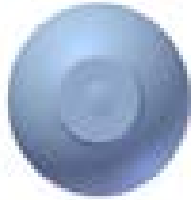
091.11 Artikelnr./ partno.800635		
Kugeldüse KD-A-06-S (Verstellbereich 180°) Ball nozzle KD-A-06-S (adjusting range 180°)		







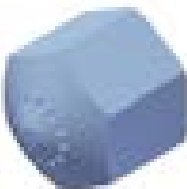



Artikelgruppe 92 Zubehör prod.group 92 addons













Artikelgruppe 92 Zubehör
 prod.group 92 addons

092.1 Artikelnr./ partno.129643		
Kugeldüse KD-I-26 Ball nozzle KD-I-26		
092.2 Artikelnr./ partno.129650		
Rohr R-IB-150 Tube R-IB-150		
092.3 Artikelnr./ partno.137273		
Rohr R-IB-100 Tube R-IB-100		
092.4 Artikelnr./ partno.137695		
Rohrenddüse RD-I-F Nozzle for tube RD-I-F		
092.5 Artikelnr./ partno.137703		
Rohrenddüse RD-I-B Nozzle for tube RD-I-B		











Artikelgruppe 92 Zubehör
 prod.group 92 addons

092.6 Artikelnr./ partno.138701		
Rohr R-IB-200 Tube R-IB-200		
092.7 Artikelnr./ partno.138719		
Rohr R-IB-250 Tube R-IB-250		
092.8 Artikelnr./ partno.138727		
Rohr R-IB-300 Tube R-IB-300		
092.9 Artikelnr./ partno.143768		
Kugeldüse KD-I-F Ball nozzle KD-I-F		
092.10 Artikelnr./ partno.144097		
Rohrenddüse RD-I-26 Nozzle for tube RD-I-26		











Artikelgruppe 92 Zubehör
 prod.group 92 addons

092.11 Artikelnr./ partno.144105		
Rohr R-IB-60 Tube R-IB-60		
092.12 Artikelnr./ partno.144113		
Kugeldüse KD-I-26-S (Verstellb. 120°) Ball nozzle KD-I-26-S (range 120°)		
092.13 Artikelnr./ partno.144121		
Kugeldüse KD-I-26-S (Verstellb. 180°) Ball nozzle KD-I-26-S (range 180°)		
092.14 Artikelnr./ partno.144139		
Kugeldüse KD-I-B Ball nozzle KD-I-B		
092.15 Artikelnr./ partno.305887		
Rohr R-IB-60 ohne Düsengewinde Tube R-IB-60 without thread		











Artikelgruppe 92 Zubehör
prod.group 92 addons

092.16 Artikelnr./ partno.305888		
Rohr R-IB-100 ohne Düsengewinde Tube R-IB-100 without threat		
092.17 Artikelnr./ partno.305889		
Rohr R-IB-150 ohne Düsengewinde Tube R-IB-150 without threat		
092.18 Artikelnr./ partno.305890		
Rohr R-IB-200 ohne Düsengewinde Tube R-IB-200 without threat		
092.19 Artikelnr./ partno.305891		
Rohr R-IB-250 ohne Düsengewinde Tube R-IB-250 without threat		
092.20 Artikelnr./ partno.305892		
Rohr R-IB-300 ohne Düsengewinde Tube R-IB-300 without threat		

Artikelgruppe 92 Zubehör
 prod.group 92 addons

092.21 Artikelnr./ partno.800383		
Umlenkung 90° für Rohrenddüse RD-I, komplett Direction change 90° for nozzle for tube RD-I, complete		
092.22 Artikelnr./ partno.801078		
Kugeldüse KD-I-10 Ballnozzle KD-I-10		
092.23 Artikelnr./ partno.801079		
Kugeldüse KD-I-15 Ballnozzle KD-I-15		
092.24 Artikelnr./ partno.801255		
Kugeldüse KD-I-30 Ball nozzle KD-I-30		
092.25 Artikelnr./ partno.801374		
Kugeldüse KD-I-20 Ball nozzle KD-I-20		







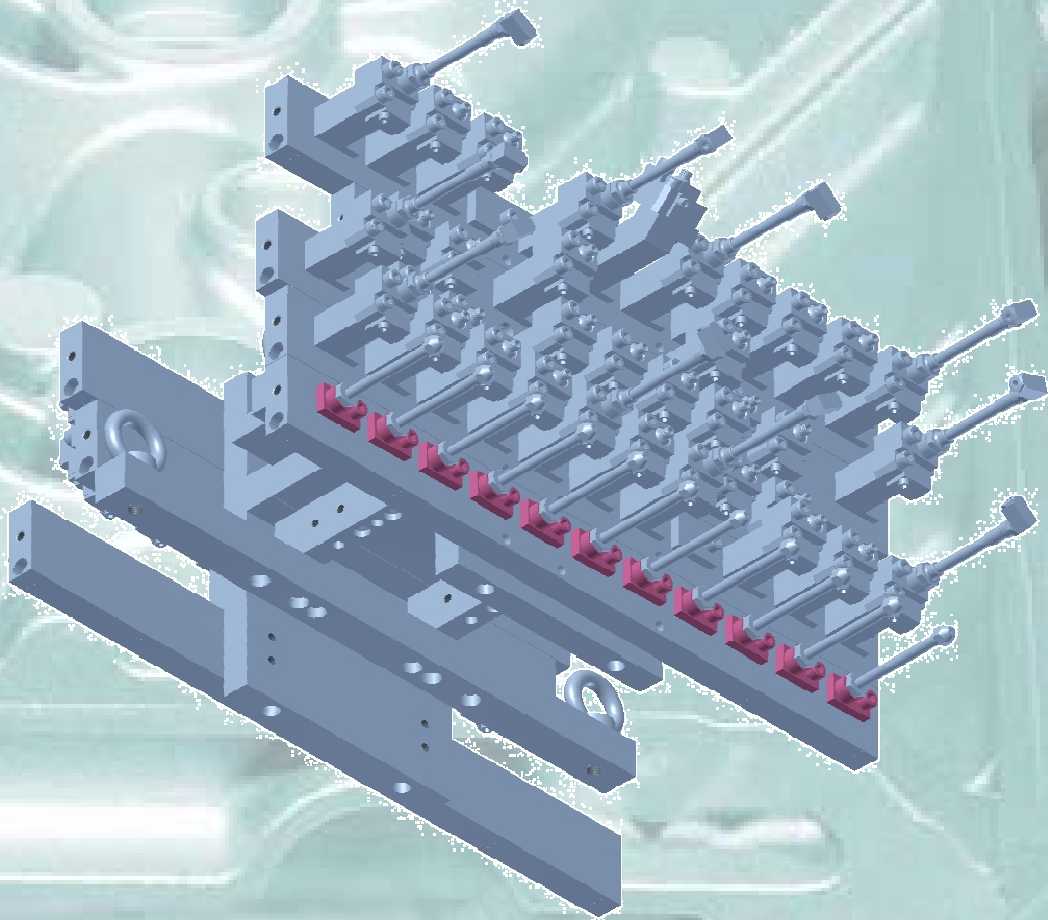

Artikelgruppe 92 Zubehör
 prod.group 92 addons

092.26 Artikelnr./ partno.801407		
<p>Rohrenddüse RD-I-B / 6 x Ø1,5mm Nozzle for tube RD-I-B / 6xØ1,5mm</p>		
092.27 Artikelnr./ partno.801491		
<p>Rohrenddüse RD-I-30 Nozzle for tube RD-I-30</p>		
092.28 Artikelnr./ partno.801493		
<p>Rohrenddüse RD-I-35 Nozzle for tube RD-I-35</p>		
092.29 Artikelnr./ partno.801495		
<p>Rohrenddüse RD-I-40 Nozzle for tube RD-I-40</p>		
092.30 Artikelnr./ partno.801503		
<p>Rohrenddüse RD-I-20 Nozzle for tube RD-I-20</p>		

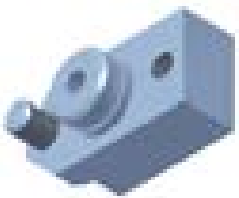
Artikelgruppe 93 Zubehör prod.group 93 addons









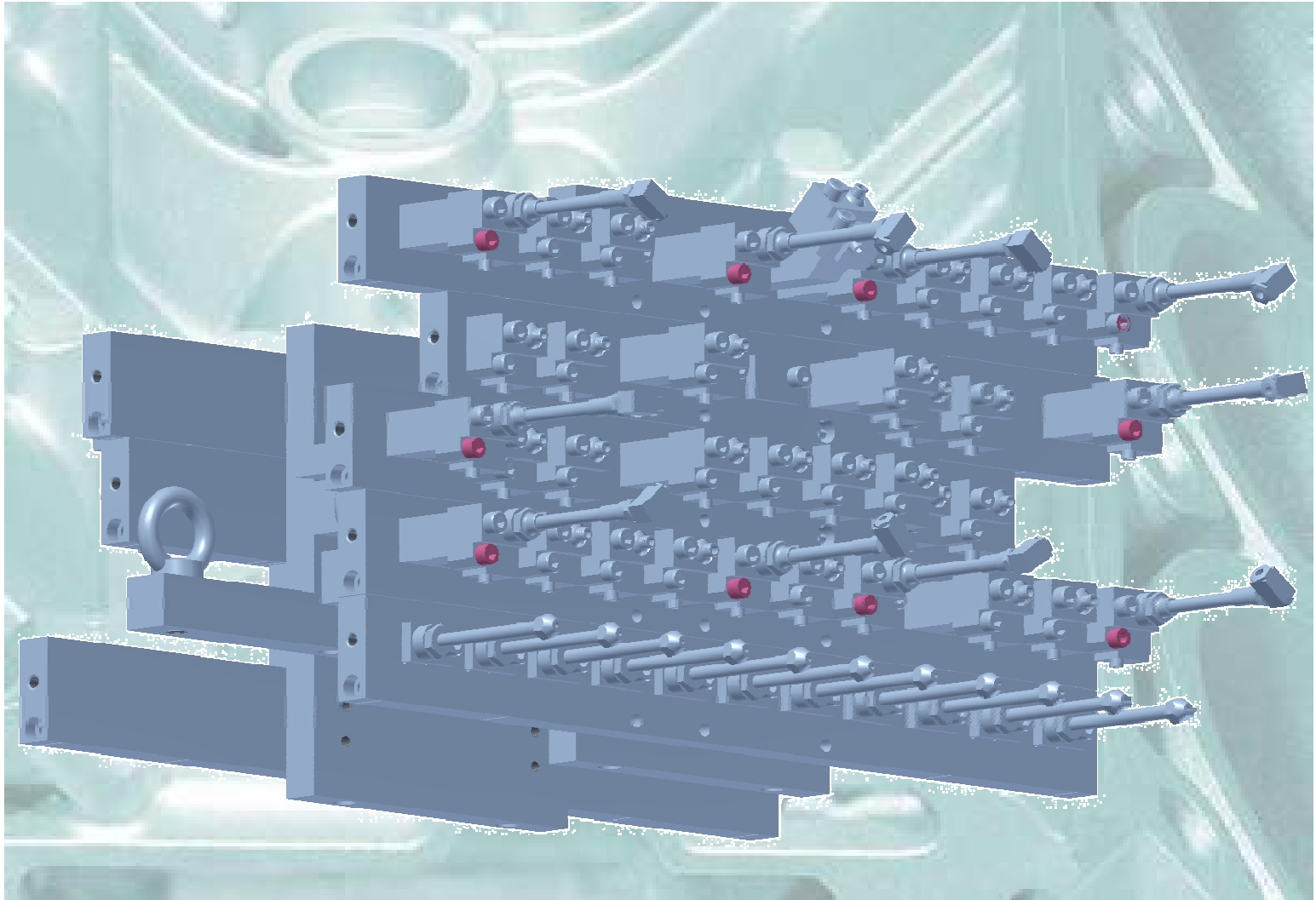



Artikelgruppe 93 Zubehör
 prod.group 93 addons

093.1 Artikelnr./ partno.179564		
<p>Halteplatte für Rohr auf Blasteiste mit Schraube M8, rechteckig, komplett Holding plate for tube on a blasting strip</p>		
093.2 Artikelnr./ partno.323017		
<p>Rückschlagventil für Blasset PS16, komplett check valve for blast. set</p>		
093.3 Artikelnr./ partno.800132		
<p>Verschuß (Blindplatte Blasdüse) mit Schraube M8 und O-Ring, gerundet, komplett Cover for blasting exit with screw M8 and O-ring, rounded, complete</p>		
093.4 Artikelnr./ partno.800774		
<p>Blasdüsenerhöhung 50mm PS16C, komplett Blasting nozzle extension 50mm PS16C, complete</p>		
093.5 Artikelnr./ partno.801342		
<p>Blasdüsenerhöhung 100mm PS16C, komplett Blasting nozzle extension 100mm PS16C, complete</p>		











Artikelgruppe 94 Zubehör prod.group 94 addons





Artikelgruppe 94 Zubehör
 prod.group 94 addons

094.1 Artikelnr./ partno.135913		
Dosierblende DB-1-06 Dosing insert DB-1-06		
094.2 Artikelnr./ partno.135939		
Dosierblende DB-0-04 Dosing insert DB-0-04		
094.3 Artikelnr./ partno.135954		
Dosierblende DB-2-08 Dosing insert DB-2-08		
094.4 Artikelnr./ partno.135970		
Dosierblende DB-3-10 Dosing insert DB-3-10		
094.5 Artikelnr./ partno.135996		
Dosierblende DB-4-12 Dosing insert DB-4-12		

Artikelgruppe 94 Zubehör
 prod.group 94 addons

094.6 Artikelnr./ partno.136150		
Dosierblende DB-6-20 Dosing insert DB-6-20		
094.7 Artikelnr./ partno.138073		
Dosierblende DB-5-16 Dosing insert DB-5-16		
094.8 Artikelnr./ partno.194142		
Dosierblende DB-E Dosing insert DB-E		
094.9 Artikelnr./ partno.800079		
Verschuß (Blindplatte Sprühdüse) mit Schraube M8 und O-Ring, gerundet, komplett Cover plate with screw M8 and O-ring, rounded, complete		
094.10 Artikelnr./ partno.801403		
Dosierblende DB-0-01 Dosing insert DB-0-01		



Artikelgruppe 094 Zubehör
prod.group 094 addons

094.11 Artikelnr./ partno.801405		
Dosierblende DB-0-02 Dosing insert DB-0-02		

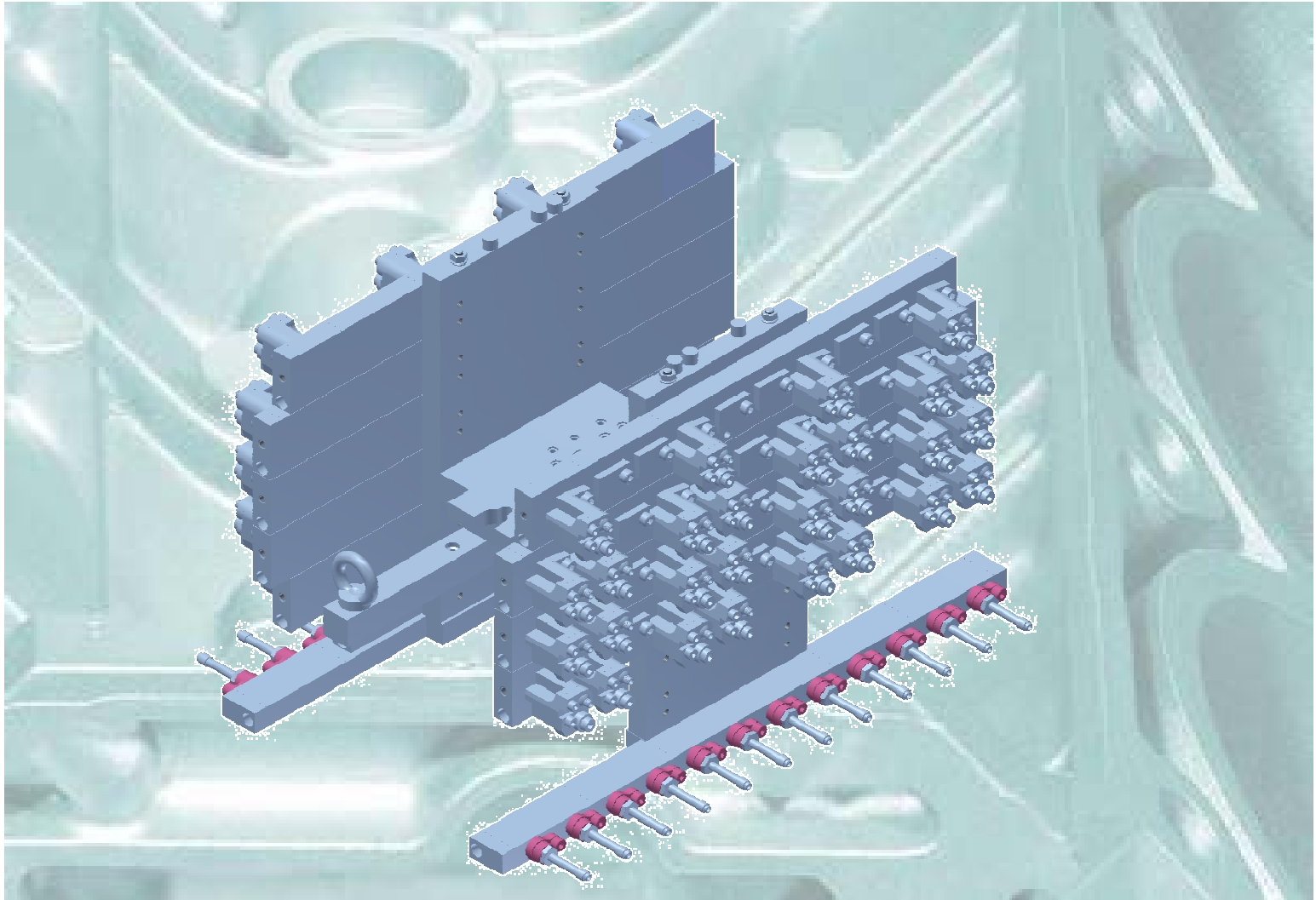
Artikelgruppe 95 Zubehör prod.group 95 addons

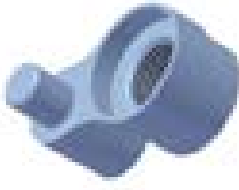

Artikelgruppe 95 Zubehör
prod.group 95 addons

095.1 Artikelnr./ partno.800009		
Klemmdeckel für Kugeldüse mit Schraube M8, gerundet, komplett Clamp plate for ball nozzle with screw M8 and O-ring, rounded, complete		
095.2 Artikelnr./ partno.800135		
Halteplatte für Rohr mit Schraube M8, gerundet, komplett Holding plate for tube with screw M8 and O-ring, rounded, complete		

Artikelgruppe 96 Zubehör prod.group 96 addons

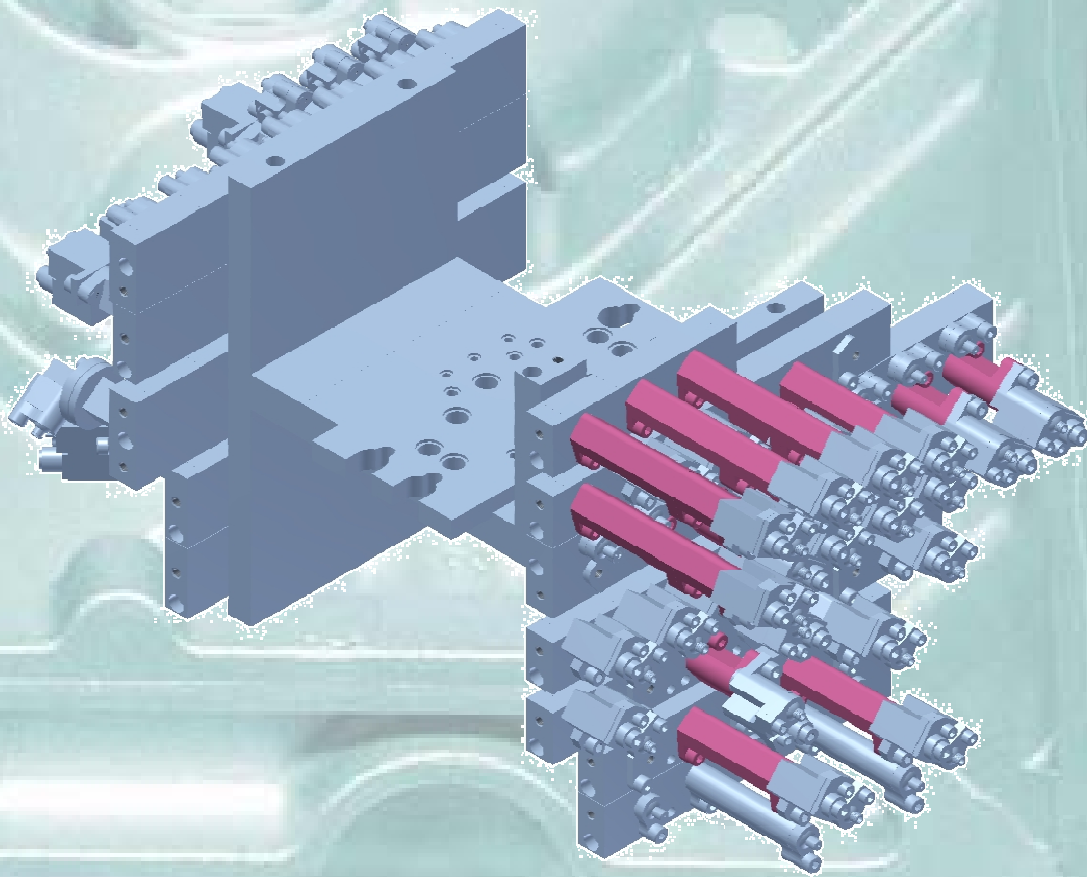

SPRÜHTECHNIK – PRODUKTKATALOG PS16CXL
 SPRAY TECHNOLOGY – PRODUCT CATALOG PS16CXL



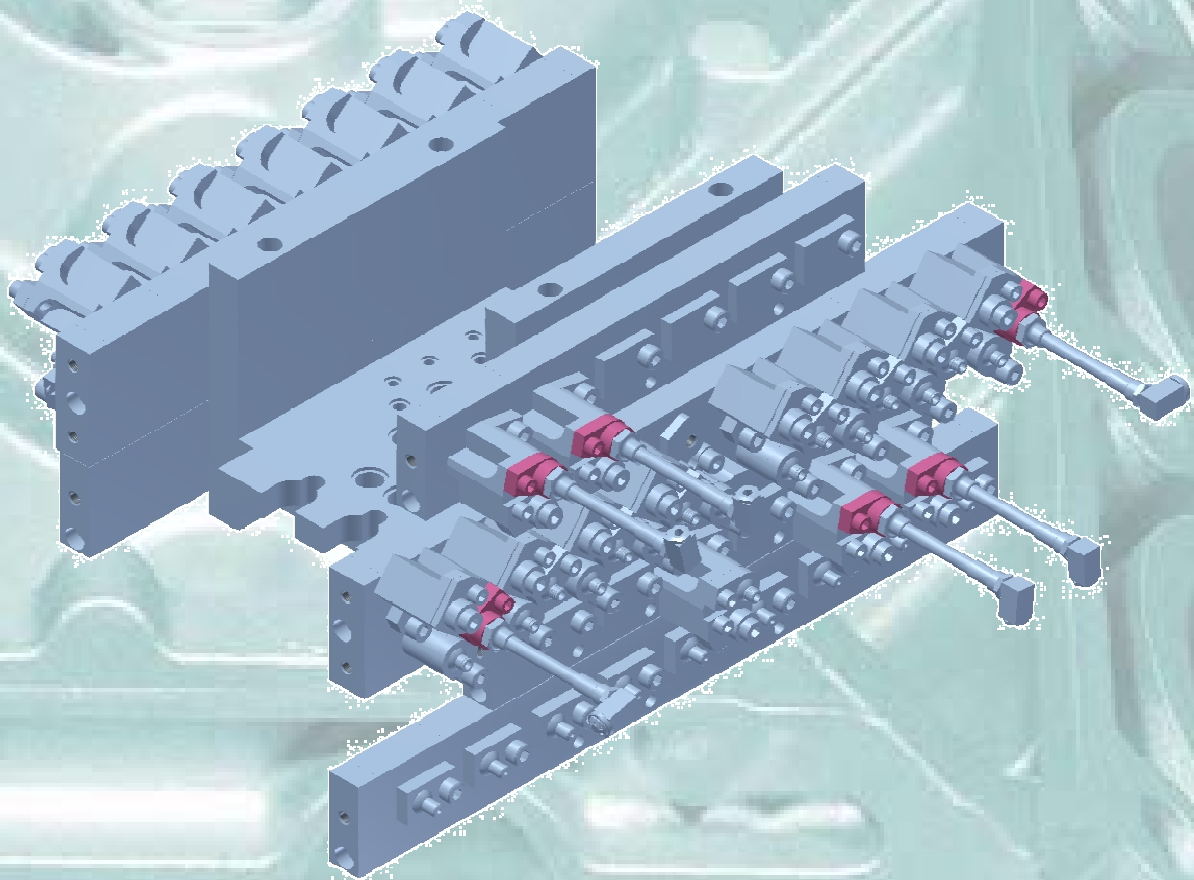

Artikelgruppe 96 Zubehör
 prod.group 96 addons

096.1 Artikelnr./ partno.800137		
Sprühdüsenerhöhung 50mm PS16C, komplett Spray nozzle extension 50mm PS16C, complete		
096.2 Artikelnr./ partno.800139		
Sprühdüsenerhöhung 100mm PS16C, komplett Spray nozzle extension 100mm PS16C, complete		
096.3 Artikelnr./ partno.800602		
Adapterplatte für Sprühdüse PS16C zu PS16, komplett Adaptor plate for spray nozzle PS16C to PS16, complete		

Artikelgruppe 97 Zubehör prod.group 97 addons





Artikelgruppe 97 Zubehör
prod.group 97 addons

097.1 Artikelnr./ partno.244822		
Halteplatte für Rohr mit Schraube M6, gerundet, komplett Holding plate for spraying tube (M6 screw)		
097.2 Artikelnr./ partno.244830		
Klemmdeckel für Kugeldüse mit Schraube M6, gerundet, komplett Clamp plate for ball nozzle with screw M6 and O-ring, rounded		

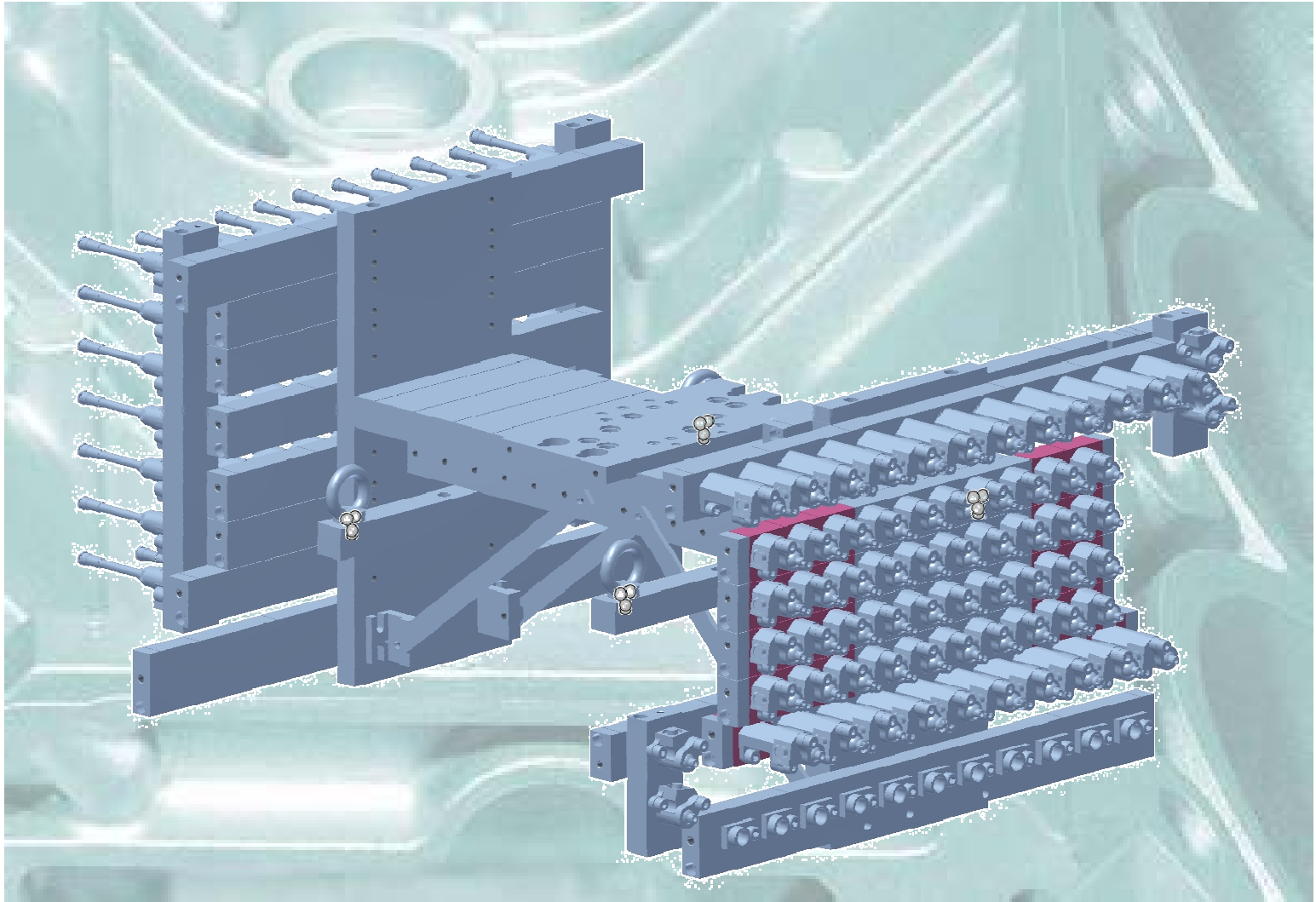
Artikelgruppe 100 Sonderteile prod.group 100 special parts



Artikelgruppe 100 Sonderteile
prod.group 100 special parts

100.1 Artikelnr./ partno.801305		
Kompaktsprühleistenmodul 45mm PS16C, komplett (sonder) Compact spray strip module 45mm PS16C, complete (special)		

Artikelgruppe 120 Zubehör prod.group 120 addons

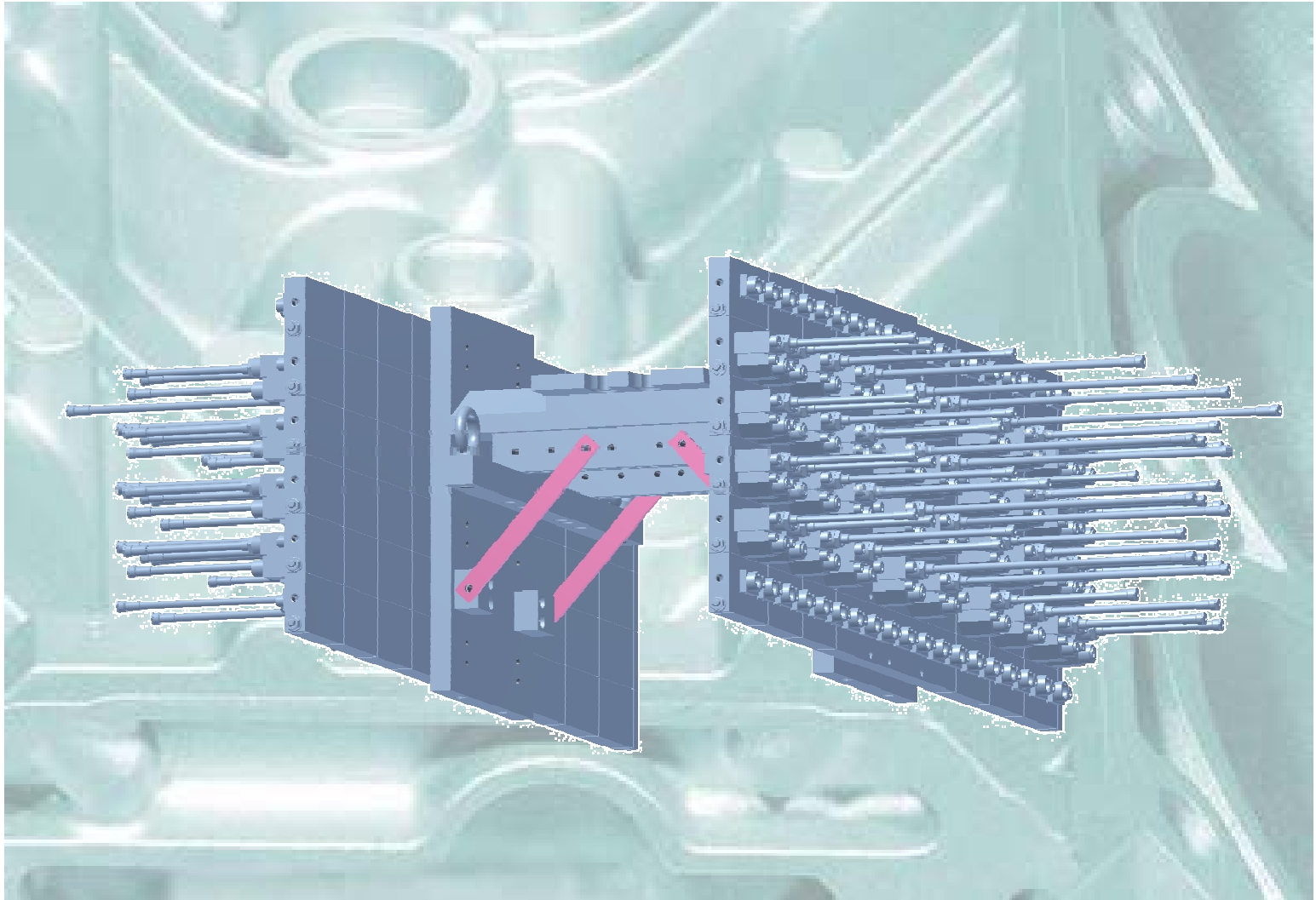

Artikelgruppe 120 Zubehör
prod.group 120 addons

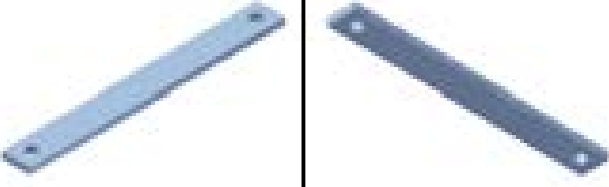
120.1 Artikelnr./ partno.301749		
Düsenjustiergerät mit Laserpointer Nozzle adjustment unit with Laser		
120.2 Artikelnr./ partno.325054		
Flachstange 20x5mm ALU, natur eloxiert, Meterware flat bar 20x5mm aluminium, anodized, sold by metre		

Inhaltsverzeichnis Table of Contents

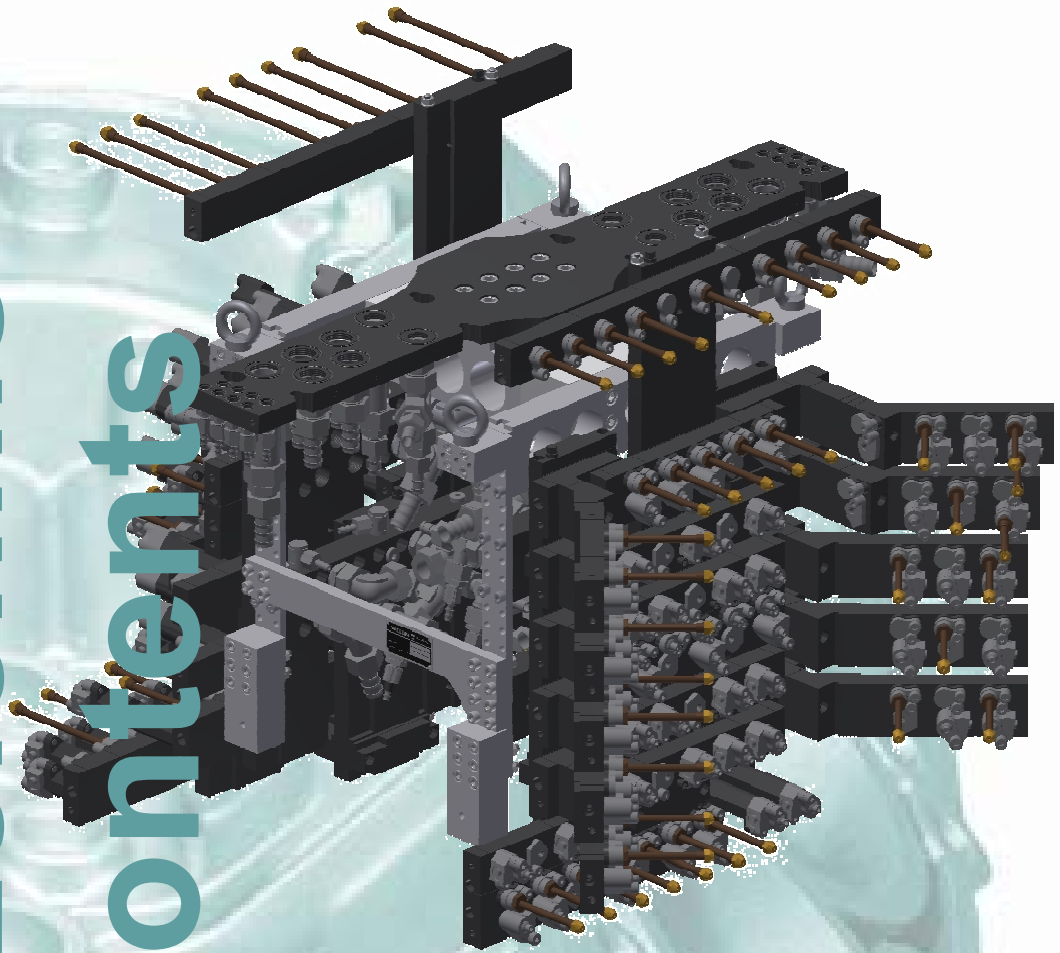

Artikelgruppe 010 Adapter
prod.group 010 adaptor

Pos	Beschreibung	Seite	Pos	description	Page
010.1	Anschlussleiste 3-fach	3	010.1	Terminal strip 3-fold	3

Artikelgruppe 011 Adaptermodule
prod.group 011 adaptor module

Pos	Beschreibung	Seite	Pos	description	Page
011.1	Adaptermodul 50mm	5	011.1	Adaptor module 50mm	5
011.2	Adaptermodul 30mm	5	011.2	Adaptor module 30mm	5
011.3	Adaptermodul 20mm	5	011.3	Adaptor module 20mm	5
011.4	Adaptermodul 55mm, 90° gedreht	5	011.4	Adaptor module 55mm, 90° turned	5
011.5	Adaptermodul 25mm	5	011.5	Adaptor module 25mm	5

Artikelgruppe 020 Verteilung Erweiterungen
prod.group 020 distribution additional

Pos	Beschreibung	Seite	Pos	description	Page
020.1	Verteilerumlenkung (vier Anschlüsse)	7	020.1	Distributor deflection (four outlets)	7
020.2	Verteilerdistanzmodul 20mm	7	020.2	Distribution distance module 20mm	7
020.3	Verteilerdistanzmodul 25mm	7	020.3	Distribution strip spacer modul 25mm	7
020.4	Verteilerdistanzmodul 30mm	7	020.4	Distribution strip spacer modul 30mm	7
020.5	Verteilerdistanzmodul 60mm	7	020.5	Distribution distance module 60mm	7
020.6	Verteilerdistanzmodul invers o.O-R	8	020.6	Distribution strip inverse modul	8
020.7	Verteilerumlenkung 45° HU	8	020.7	Distributor deflection 45° HU	8
020.8	Verteilerschließplatte U	8	020.8	Distribution cover down	8
020.9	Verteilerdistanzmodul invers m.O-R	8	020.9	Distribution strip inverse modul	8
020.10	Verteilerschließplatte O	8	020.10	Distributor cover above	8
020.11	Verteilerdistanzmodul 15mm	9	020.11	Distribution distance module 15mm	9

Artikelgruppe 022 Verteilung kompakt
prod.group 022 distribution compact

Pos	Beschreibung	Seite	Pos	description	Page
022.1	Verteilerleiste (kompakt)	11	022.1	Distribution strip (compact)	11

SPRÜHTECHNIK – PRODUKTKATALOG PS16CXL
SPRAY TECHNOLOGY – PRODUCT CATALOG PS16CXL

Artikelgruppe 022 Verteilung kompakt
prod.group 022 distribution compact

Pos	Beschreibung	Seite	Pos	description	Page
022.2	Verteilerleistenmodul (kompakt)	11	022.2	Distribution strip module (compact)	11
022.3	Verteilerleistenmodul (kompakt) mit Anschluss	11	022.3	Distribution strip mod. (compact) w. connection	11
022.4	Verteileranschlussleiste (kompakt)	11	022.4	Distribution connection strip (compact)	11

Artikelgruppe 023 Verteilung kombi
prod.group 023 distribution combi

Pos	Beschreibung	Seite	Pos	description	Page
023.1	Verteilerleiste (kombi)	13	023.1	Distribution strip (combi)	13
023.2	Verteilerleistenmodul (kombi)	13	023.2	Distribution strip module (combi)	13
023.3	Verteileranschlussleiste (kombi)	13	023.3	Distribution connection strip (combi)	13
023.4	Verteilerleistenmodul (kombi)	13	023.4	Distribution strip module (combi)	13
023.5	Verteilerleistenmodul (kombi)	13	023.5	Distribution strip module (combi)	13
023.6	Verteilerleiste (kombi)	14	023.6	Distribution strip (combi)	14
023.7	Verteilerleistenmodul (kombi)	14	023.7	Distribution strip module (combi)	14
023.8	Verteilerleistenmodul (kombi)	14	023.8	Distribution strip module (combi)	14

Artikelgruppe 025 Verteilung kompakt blasen
prod.group 025 distribution compact blasting

Pos	Beschreibung	Seite	Pos	description	Page
025.1	Verteilerleistenmodul (kompakt blasen)	16	025.1	Distribution strip module (compact blasting)	16
025.2	Verteilerleiste (kompakt blasen)	16	025.2	Distribution strip module (compact blasting)	16

Artikelgruppe 031 Sprühleisten kompakt
prod.group 031 spray strips compact

Pos	Beschreibung	Seite	Pos	description	Page
031.1	Kompaktsprühleiste 150mm	18	031.1	Compact spray strip 150mm	18

Artikelgruppe 032 Sprühleisten kombi
prod.group 032 spray strips combi

Pos	Beschreibung	Seite	Pos	description	Page
032.1	Kombisprühleiste 150mm	20	032.1	Combi spray strip 150mm	20
032.2	Kombianschlussleiste 100mm	20	032.2	Combi connection strip 100mm	20

SPRÜHTECHNIK – PRODUKTKATALOG PS16CXL
SPRAY TECHNOLOGY – PRODUCT CATALOG PS16CXL

Artikelgruppe 032 Sprühleisten kombi
prod.group 032 spray strips combi

Pos	Beschreibung	Seite	Pos	description	Page
032.3	Kombianschlussleiste 100mm	20	032.3	Combi connection strip 100mm	20
032.4	Kombisprühleiste 150mm	20	032.4	Combi spray strip 150mm	20
032.5	Kombianschlussleiste 100mm mit 90° Winkel	20	032.5	Combi connection strip 100mm with 90°angel	20
032.6	Kombianschlussleiste 100mm mit 90° Winkel	21	032.6	Combi connection strip 100mm with 90°angel	21

Artikelgruppe 034 Blasleisten kompakt
prod.group 034 blast strips compact

Pos	Beschreibung	Seite	Pos	description	Page
034.1	Blasleiste 150mm	23	034.1	Blasting strip 150mm	23

Artikelgruppe 041 Sprühleisten Erweiterung kompakt
prod.group 041 spray strips additional compact

Pos	Beschreibung	Seite	Pos	description	Page
041.1	Kompaktsprühleistenmodul 100mm	25	041.1	Compact spray strip module 100mm	25
041.2	Kompaktsprühleistenschliessleiste R	25	041.2	Cover for compact spray strip R	25
041.3	Kompaktsprühleistenschliessleiste L	25	041.3	Cover for compact spray strip L	25
041.4	Kompaktsprühleistenmodul 50mm	25	041.4	Compact spray strip module 50mm	25
041.5	Kompaktsprühleistenkreuzung	25	041.5	Compact spray strip junction	25
041.6	Kompaktsprühleistenwinkel 1	26	041.6	Angle 1 for compact spray strips	26
041.7	Kompaktsprühleistenwinkel 2	26	041.7	Angle 2 for compact spray strips	26
041.8	Kompaktsprühleistenwinkel 3	26	041.8	Angle 3 for compact spray strips	26
041.9	Kompaktsprühleistenwinkel 4	26	041.9	Angle 4 for compact spray strips	26
041.10	Kompaktsprühleistendistanzmodul 100mm	26	041.10	Compact spray strip spacer modul 100mm	26
041.11	Kompaktsprühleistendistanzmodul 50mm	27	041.11	Compact spray strip spacer modul 50mm	27
041.12	Kompaktsprühleistenwinkelstück 45°LHA	27	041.12	Compact spray strip angled piece 45°LHA	27
041.13	Kompaktsprühleistenwinkelstück 45°LVI	27	041.13	Compact spray strip angeled piece 45°LVI	27
041.14	Kompaktsprühleistenwinkelstück 45°RHA	27	041.14	Compact spray strip angled piece 45°RHA	27
041.15	Kompaktsprühleistenwinkelstück 45°RVI	27	041.15	Compact spray strip angled piece 45°RVI	27
041.16	Kompaktsprühleistendistanzmodul 10mm	28	041.16	Compact spray strip spacer module 10mm	28
041.17	Kompaktsprühleisten-Inversmodul o.O-R	28	041.17	Compact spray strip inverse module	28
041.18	Kompaktsprühleisten-Inversmodul m.O-R	28	041.18	Compact spray strip inverse module	28
041.19	Kompaktsprühleistendistanzmodul 15mm	28	041.19	Compact spray strip spacer module 10mm	28
041.20	Kompaktsprühabschlußleiste 50mm rechts	28	041.20	Right end compact spray strip module 50mm	28
041.21	Kompaktsprühabschlußleiste 50mm links	29	041.21	Left end compact spray strip module 50mm	29

Artikelgruppe 042 Sprühleisten Erweiterung kombi
prod.group 042 spray strips additional combi

Pos	Beschreibung	Seite	Pos	description	Page
042.1	Kombisprühleistenmodul 100mm	31	042.1	Combi spray strip module 100mm	31

SPRÜHTECHNIK – PRODUKTKATALOG PS16CXL
SPRAY TECHNOLOGY – PRODUCT CATALOG PS16CXL

Artikelgruppe 042 Sprühleisten Erweiterung kombi
prod.group 042 spray strips additional combi

Pos	Beschreibung	Seite	Pos	description	Page
042.2	Kombisprühleistenschliessleiste R	31	042.2	Cover for combi spray strip R	31
042.3	Kombisprühleistenschliessleiste L	31	042.3	Cover for combi spray strip L	31
042.4	Kombisprühleistenmodul 50mm	31	042.4	Combi spray strip module 50mm	31
042.5	Kombisprühleistenkreuzung	31	042.5	Combi spray strip junction	31
042.6	Kombisprühleistenwinkel 1	32	042.6	Angle 1 for combi spray strips	32
042.7	Kombisprühleistenwinkel 2	32	042.7	Angle 2 for combi spray strips	32
042.8	Kombisprühleistenwinkel 3	32	042.8	Angle 3 for combi spray strips	32
042.9	Kombisprühleistenwinkel 4	32	042.9	Angle 4 for combi spray strips	32
042.10	Kombisprühleistendistanzmodul 100mm	32	042.10	Combi spray strip spacer module 100mm	32
042.11	Kombisprühleistendistanzmodul 50mm	33	042.11	Combi spray strip spacer module 50mm	33
042.12	Kombisprühleistenwinkelstück 45°LHA	33	042.12	Combi spray strip angled piece 45°LHA	33
042.13	Kombisprühleistenwinkelstück 45°LVI	33	042.13	Combi spray strip angled piece 45°LVI	33
042.14	Kombisprühleistenwinkelstück 45°RHA	33	042.14	Combi spray strip angled piece 45°RHA	33
042.15	Kombisprühleistenwinkelstück 45°RVI	33	042.15	Combi spray strip angled piece 45°RVI	33
042.16	Kombisprühleistendistanzmodul 10mm	34	042.16	Combi spray strip spacer module 10mm	34
042.17	Kombisprühleisten-Inversmodul o.O-R	34	042.17	Combi spray strip inverse module	34
042.18	Kombisprühleisten-Inversmodul m.O-R	34	042.18	Combi spray strip inverse module	34
042.19	Kombisprühabschlußleiste 50mm rechts	34	042.19	Right end combispray strip module 50mm	34
042.20	Kombisprühabschlußleiste 50mm links	34	042.20	Left end combispray strip module 50mm	34
042.21	Kombisprühleistenmodul 50mm	35	042.21	Combi spray strip module 50mm	35

Artikelgruppe 044 Blasleisten Erweiterung kompakt
prod.group 044 blast strips additional compact

Pos	Beschreibung	Seite	Pos	description	Page
044.1	Blasleistenmodul 100mm	37	044.1	Blasting strip module 100mm	37
044.2	Blasleistenmodul 50mm	37	044.2	Blasting strip module 50mm	37
044.3	Blasleistenschliessleiste R (kompakt)	37	044.3	Cover for compact blasting strip R	37
044.4	Blasleistenschliessleiste L (kompakt)	37	044.4	Cover for compact blasting strip L	37
044.5	Blasleistenkreuzung	37	044.5	Blasting strip junction	37
044.6	Blasleistenwinkel 1	38	044.6	Angle 1 for blast strip 45	38
044.7	Blasleistenwinkel 2	38	044.7	angle 2 for blasting strip 45	38
044.8	Blasleistenwinkel 3	38	044.8	Angle 3 for blast strip 45	38
044.9	Blasleistenwinkel 4	38	044.9	Angle 4 for blast strip 45	38
044.10	Blasleistendistanzmodul 100mm	38	044.10	Blasting strip spacer module 100mm	38
044.11	Blasleistendistanzmodul 50mm	39	044.11	Blasting strip spacer module 50mm	39
044.12	Blasleistenwinkelstück 45°LHA	39	044.12	Blasting strip angled piece 45°LHA	39
044.13	Blasleistenwinkelstück 45°LVI	39	044.13	Blasting strip angled piece 45°LVI	39
044.14	Blasleistenwinkelstück 45°RHA	39	044.14	Blasting strip angled piece 45°RHA	39

SPRÜHTECHNIK – PRODUKTKATALOG PS16CXL
SPRAY TECHNOLOGY – PRODUCT CATALOG PS16CXL

Artikelgruppe 044 Blasleisten Erweiterung kompakt
prod.group 044 blast strips additional compact

Pos	Beschreibung	Seite	Pos	description	Page
044.15	Blasleistenwinkelstück 45°RVI	39	044.15	Blasting strip angled piece 45°RVI	39
044.16	Blasleistendistanzmodul 10mm	40	044.16	Blasting strip spacer module 10mm	40
044.17	Blasleisten-Inversmodul o.O-R	40	044.17	Blasting strip inverse module	40
044.18	Blasleisten-Inversmodul m.O-R	40	044.18	Blasting strip inverse module	40

Artikelgruppe 050 Sprühdüsen außenmisch
prod.group 050 spray nozzles outside mixing

Pos	Beschreibung	Seite	Pos	description	Page
050.1	Sprühdüse SD14	42	050.1	Spray nozzle SD14	42
050.2	Sprühdüse SD14 Basis	42	050.2	Spray nozzle SD14 carrier	42
050.3	Sprühdüse SD14	42	050.3	Spray nozzle	42
050.4	Sprühdüse SD14	42	050.4	Spray nozzle	42
050.5	Sprühdüse SD14	42	050.5	Spray nozzle	42
050.6	Sprühdüse SD14	43	050.6	Spray nozzle	43
050.7	Sprühdüse SD14	43	050.7	Spray nozzle	43
050.8	Sprühdüse SD14	43	050.8	Spray nozzle	43
050.9	Sprühdüse SD14	43	050.9	Spray nozzle	43
050.10	Sprühdüse SD14	43	050.10	Spray nozzle	43

Artikelgruppe 070 Blasdüsen
prod.group 070 blast nozzles

Pos	Beschreibung	Seite	Pos	description	Page
070.1	Blas-Set mit KD-I-26	45	070.1	Blasting set with KD-I-26	45
070.2	Blas-Set mit KD-I-30	45	070.2	Blasting set with KD-I-30	45
070.3	Blas-Set mit KD-I-26 (50mm lang)	45	070.3	Blasting set with KD-I-26 (50mm)	45
070.4	Blas-Set mit KD-I-20	45	070.4	Blasting set with KD-I-20	45

Artikelgruppe 080 ECO-Spray Düsen
prod.group 080 ECO-spray nozzles

Pos	Beschreibung	Seite	Pos	description	Page
080.1	Dosierdüse	47	080.1	Dosing nozzle	47
080.2	Dosierdüse Basis	47	080.2	dosing nozzle carrier	47
080.3	Dosierdüse	47	080.3	Dosing nozzle	47
080.4	Dosierdüse Basis	47	080.4	dosing nozzle carrier	47

SPRÜHTECHNIK – PRODUKTKATALOG PS16CXL
SPRAY TECHNOLOGY – PRODUCT CATALOG PS16CXL

Artikelgruppe 080 ECO-Spray Düsen
prod.group 080 ECO-spray nozzles

Pos	Beschreibung	Seite	Pos	description	Page
080.5	Dosierdüse	47	080.5	Dosing nozzle	47
080.6	Dosierdüse Basis	48	080.6	dosing nozzle carrier	48
080.7	Dosierdüse	48	080.7	Dosing nozzle	48
080.8	Dosierdüse	48	080.8	Dosing nozzle	48
080.9	Dosierdüse Basis	48	080.9	Dosing nozzle carrier	48
080.10	Dosierdüse	48	080.10	Dosing nozzle	48
080.11	Dosierdüse	49	080.11	Dosing nozzle	49
080.12	Dosierdüse Basis	49	080.12	Dosing nozzle carrier	49
080.13	Kappe mit Festanschlag 1	49	080.13	Cap with fixed stop 1	49
080.14	Kappe mit Festanschlag 2	49	080.14	Cap with fixed stop 2	49
080.15	Kappe mit Festanschlag 3	49	080.15	Cap with fixed stop 3	49
080.16	Kappe mit Festanschlag 4	50	080.16	Cap with fixed stop 4	50
080.17	Kappe mit Festanschlag 5	50	080.17	Cap with fixed stop 5	50
080.18	Kappe mit Festanschlag 6	50	080.18	Cap with fixed stop 6	50
080.19	Dosierdüse Basis	50	080.19	Dosing nozzle carrier	50
080.20	Sprühdüse FSD	50	080.20	Spray nozzle FSD	50
080.21	Sprühdüse FSD	51	080.21	Spray nozzle FSD	51
080.22	Sprühdüse FSD Basis	51	080.22	Spray nozzle FSD basis	51
080.23	Sprühdüse FSD	51	080.23	Spray nozzle FSD	51

Artikelgruppe 090 Zubehör außenmisch
prod.group 090 addons outside mixing

Pos	Beschreibung	Seite	Pos	description	Page
090.1	Rohr	53	090.1	Tube	53
090.2	Rohr	53	090.2	Tube	53
090.3	Rohr	53	090.3	Tube	53
090.4	Rohr	53	090.4	Tube	53
090.5	Rohr	53	090.5	Tube	53
090.6	Rohrenddüse	54	090.6	Nozzle for tube	54
090.7	Rohrenddüse	54	090.7	Nozzle for tube	54
090.8	Rohrenddüse	54	090.8	Nozzle for tube	54
090.9	Verschluss für Sprührohr AM	54	090.9	blind plug	54
090.10	Umlenkung 90°	54	090.10	Direction change 90°	54
090.11	T-Umlenkung	55	090.11	T-direction change	55
090.12	L-Umlenkung	55	090.12	L-direction change	55
090.13	Rohrenddüse	55	090.13	Nozzle for tube	55

Artikelgruppe 091 Zubehör außenmisch/ECO-Spray
prod.group 091 addons outside mixing/ECO-spray

Pos	Beschreibung	Seite	Pos	description	Page
091.1	Kugeldüse	57	091.1	Ball nozzle	57

SPRÜHTECHNIK – PRODUKTKATALOG PS16CXL
SPRAY TECHNOLOGY – PRODUCT CATALOG PS16CXL

Artikelgruppe 091 Zubehör außenmisch/ECO-Spray
prod.group 091 addons outside mixing/ECO-spray

Pos	Beschreibung	Seite	Pos	description	Page
091.2	Kugeldüse	57	091.2	Ball nozzle	57
091.3	Kugeldüse	57	091.3	Ball nozzle	57
091.4	Kugeldüse	57	091.4	Ball nozzle	57
091.5	Kugeldüse	57	091.5	Ball nozzle	57
091.6	Kugeldüse	58	091.6	Ball nozzle	58
091.7	Kugeldüse	58	091.7	Ball nozzle	58
091.8	Kugeldüse	58	091.8	Ball nozzle	58
091.9	Kugeldüse	58	091.9	Ball nozzle	58
091.10	Kugeldüse	58	091.10	Ball nozzle	58
091.11	Kugeldüse	59	091.11	Ball nozzle	59

Artikelgruppe 092 Zubehör innenmisch/blasen
prod.group 092 addons inside/blast mixing

Pos	Beschreibung	Seite	Pos	description	Page
092.1	Kugeldüse	61	092.1	Ball nozzle	61
092.2	Rohr	61	092.2	Tube	61
092.3	Rohr	61	092.3	Tube	61
092.4	Rohrenddüse	61	092.4	Nozzle for tube	61
092.5	Rohrenddüse	61	092.5	Nozzle for tube	61
092.6	Rohr	62	092.6	Tube	62
092.7	Rohr	62	092.7	Tube	62
092.8	Rohr	62	092.8	Tube	62
092.9	Kugeldüse	62	092.9	Ball nozzle	62
092.10	Rohrenddüse	62	092.10	Nozzle for tube	62
092.11	Rohr	63	092.11	Tube	63
092.12	Kugeldüse	63	092.12	Ball nozzle	63
092.13	Kugeldüse	63	092.13	Ball nozzle	63
092.14	Kugeldüse	63	092.14	Ball nozzle	63
092.15	Rohr	63	092.15	Tube	63
092.16	Rohr	64	092.16	Tube	64
092.17	Rohr	64	092.17	Tube	64
092.18	Rohr	64	092.18	Tube	64
092.19	Rohr	64	092.19	Tube	64
092.20	Rohr	64	092.20	Tube	64
092.21	Umlenkung 90°	65	092.21	Direction change 90°	65
092.22	Kugeldüse	65	092.22	Ballnozzle	65
092.23	Kugeldüse	65	092.23	Ballnozzle	65
092.24	Kugeldüse	65	092.24	Ball nozzle	65

SPRÜHTECHNIK – PRODUKTKATALOG PS16CXL
SPRAY TECHNOLOGY – PRODUCT CATALOG PS16CXL

Artikelgruppe 092 Zubehör innenmisch/blasen
prod.group 092 addons inside/blast mixing

Pos	Beschreibung	Seite	Pos	description	Page
092.25	Kugeldüse	65	092.25	Ball nozzle	65
092.26	Rohrenddüse	66	092.26	Nozzle for tube	66
092.27	Rohrenddüse	66	092.27	Nozzle for tube	66
092.28	Rohrenddüse	66	092.28	Nozzle for tube	66
092.29	Rohrenddüse	66	092.29	Nozzle for tube	66
092.30	Rohrenddüse	66	092.30	Nozzle for tube	66

Artikelgruppe 093 Zubehör blasen
prod.group 093 addons blast

Pos	Beschreibung	Seite	Pos	description	Page
093.1	Halteplatte für Rohr auf Blasteiste	68	093.1	Holding plate for tube	68
093.2	Rückschlagventil für Blasset	68	093.2	check valve for blast. set	68
093.3	Verschuß (Blindplatte Blasdüse)	68	093.3	Cover for blasting exit	68
093.4	Blasdüsenerhöhung 50mm	68	093.4	Blasting nozzle extension 50mm	68
093.5	Blasdüsenerhöhung 100mm	68	093.5	Blasting nozzle extension 100mm	68

Artikelgruppe 094 Zubehör außenmisch/innenmisch
prod.group 094 addons outside/inside mixing

Pos	Beschreibung	Seite	Pos	description	Page
094.1	Dosierblende	70	094.1	Dosing insert	70
094.2	Dosierblende	70	094.2	Dosing insert	70
094.3	Dosierblende	70	094.3	Dosing insert	70
094.4	Dosierblende	70	094.4	Dosing insert	70
094.5	Dosierblende	70	094.5	Dosing insert	70
094.6	Dosierblende	71	094.6	Dosing insert	71
094.7	Dosierblende	71	094.7	Dosing insert	71
094.8	Dosierblende	71	094.8	Dosing insert	71
094.9	Verschuß (Blindplatte Sprühdüse)	71	094.9	Cover plate	71
094.10	Dosierblende	71	094.10	Dosing insert	71
094.11	Dosierblende	72	094.11	Dosing insert	72

Artikelgruppe 095 Zubehör außen-/innenmisch/blasen
prod.group 095 addons outside/inside mixing blast

Pos	Beschreibung	Seite	Pos	description	Page
095.1	Klemmdeckel für Kugeldüse	74	095.1	Clamp plate for ball nozzle	74

SPRÜHTECHNIK – PRODUKTKATALOG PS16CXL
SPRAY TECHNOLOGY – PRODUCT CATALOG PS16CXL

Artikelgruppe 095 Zubehör außen-/innenmisch/blasen
prod.group 095 addons outside/inside mixing blast

Pos	Beschreibung	Seite	Pos	description	Page
095.2	Halteplatte für Rohr	74	095.2	Holding plate for tube	74

Artikelgruppe 096 Zubehör außen-/innenmisch/ECO-Spray
prod.group 096 addons outside/inside mixing/ECO

Pos	Beschreibung	Seite	Pos	description	Page
096.1	Sprühdüsenerhöhung 50mm	76	096.1	Spray nozzle extension 50mm	76
096.2	Sprühdüsenerhöhung 100mm	76	096.2	Spray nozzle extension 100mm	76
096.3	Adapterplatte für Sprühdüse	76	096.3	Adaptor plate for spray nozzle	76

Artikelgruppe 097 Zubehör ECO-Spray
prod.group 097 addons ECO-spray

Pos	Beschreibung	Seite	Pos	description	Page
097.1	Halteplatte für Rohr	78	097.1	Holding plate	78
097.2	Klemmdeckel für Kugeldüse	78	097.2	Clamp plate for ball nozzle	78

Artikelgruppe 100 Sonderteile
prod.group 100 special parts

Pos	Beschreibung	Seite	Pos	description	Page
100.1	Kompaktsprühleistenmodul 45mm	80	100.1	Compact spray strip module 45mm	80

Artikelgruppe 120 Zubehör
prod.group 120 addons

Pos	Beschreibung	Seite	Pos	description	Page
120.1	Düsenjustiergerät	82	120.1	Nozzle adjustment unit	82
120.2	Flachstange 20x5mm	82	120.2	flat bar 20x5mm	82